

**TUNGSRAM™**

Innovation is our heritage  
EST. 1896

# Automotive Lamp Catalogue

Catalogue Lampes Auto  
Kfz-Lampen Katalog  
Catalogo Lampade Automotive  
Catálogo Lámparas de Automoción





### Tungsrám's unwavering commitment to quality is a guarantee that our products and services meet your needs under all circumstances

Our light sources and solutions will conform to the prevailing regulations at all times. At Tungsrám, customer needs take centerstage: our customized products and solutions are based on cutting edge technology coupled with vast expertise. Innovation is in our DNA. We rely on innovative technologies and solutions to continuously develop more efficient products and services. We are committed to building a sustainable and bright future together.

Our professional track record spanning more than a century and broad product portfolio that fully complies with legal requirements is a guarantee that our customers will always find the product and service that meets their needs.

### WE ARE MORE THAN JUST LIGHTING

Tungsrám is reinvigorating a 125-year-old tradition of playing a leading role in manufacturing technology and service solutions. Tungsrám is present **100 global markets and exports 95% of its production**. Its highlyproductive supply chain is centered around its **5 factories in Hungary working to the highest quality standards with its 3700 employees and a network of 1600 suppliers and partners around the globe**.

Tungsrám Group invests into future-safe technologies and dynamically growing global markets, such as smart solutions, smart cities, indoor farming and healthcare, while still strengthening the lighting core of its business.

**Tungsrám's automotive** division has been meeting the highest quality standards for passenger cars and utility vehicles for more than half a century. Listed among the top three car lamp manufacturers globally, we are an established supplier of OEMs (Original Equipment Manufacturers) and a decisive player in aftermarket sales in major markets worldwide.

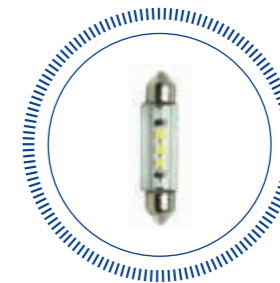
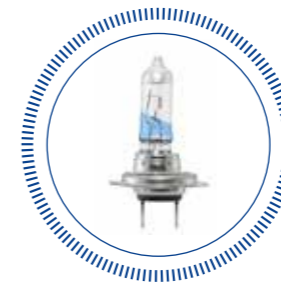
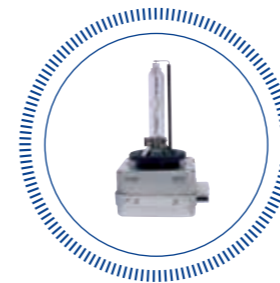

### Tungsrám's range of products are all developed in close collaboration with automotive manufacturers from across the Globe

Not only does this guarantee that our products meet the highest quality standards of every make and model of vehicle on the road today, it also means that customers will have access to high-quality, affordable replacement parts.

Tungsrám automotive lamps significantly improve visibility and safety for drivers - keeping in mind the design principle „see and be seen“. As well as the basic range, Tungsrám Automotive offers the premium range, based on special lamp designs - providing more light on the road. The premium lamps are also E1 marked, making their use on the EU roads possible. The main objective when developing the premium lamps is to effectively help in improving driving performance at night time & in poor visibility conditions, maximizing driver's visibility, reducing the risk of road accidents.

Our constant quality aim is Zero Defects. This involves designing quality into the lamps leading to suitability and reliability with a high standard of quality equalling that of the manufacturing technologies.

Our lamps are manufactured to strict international standards and appropriately marked in conformance with E.C.E. regulations or with other standards (DIN, ANSI).

Our renowned automotive lighting ranges include basic and premium lamps for original equipment and aftermarket, and we supply products for all major auto brands.



ISO 9001,  
IATF 16949



ECE compliance,  
homologation



Global OEM  
customer base



Use of UV cut glass,  
safe for use in plastic  
headlights



EoLV  
compliance

# Contents

Introduction, Contents,  
Automotive lamps

2



12V

34

12V Halogen headlight lamps	34
12V Miniature lamps	36



LED retrofit lamps

6



24V

42

Heavy Star 24V - including miniature lamps	42
24V Headlight lamps	44
24V Miniature lamps	44



XENSATION™ headlight lamps

12



Lamp kits

47

12V halogen headlight  
lamps - "PREMIUM"

14

Accessories

48

Megalight Ultra +200	16
Megalight Ultra +150	18
Megalight Ultra +130	20
Megalight Ultra +120	22
Megalight Ultra +90	24
Megalight Plus 50,60	25
Sportlight Extreme	26
Sportlight Ultra	27
Sportlight - including miniature lamps	28
Long Life - including miniature lamps	30
Rally - Off Road	32

Tungfram packaging design

52

SKU/EAN reference,  
Tungfram Blister range

54

Symbols & marking,  
Lamp bases

57

## Legend

ECE category	Tungfram type nr	pack unit	lifetime	rated wattage	base	figure	product code	EAN code

# Tungfram EU Road Legal Automotive Lamps

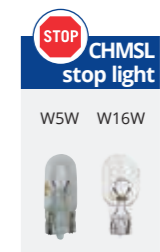
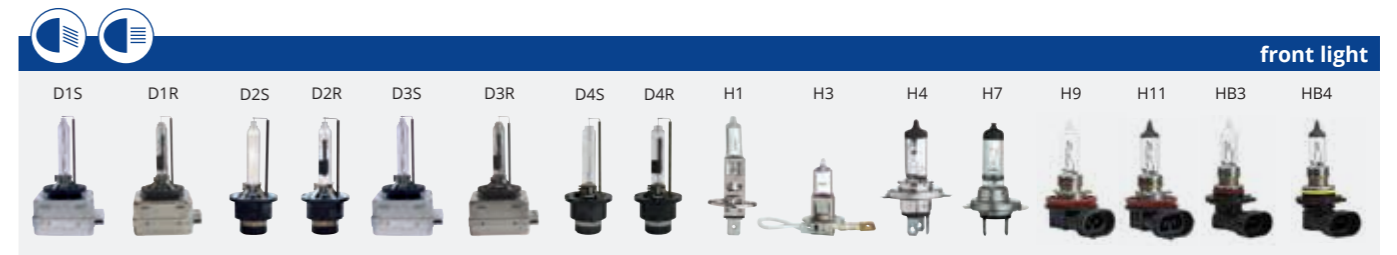



# LED Retrofit Headlight Lamps

OFF ROAD

**TUNGSRAM LED RETROFIT HEADLIGHT LAMPS** are designed for passionate people, looking for adventure, style and ultimate performance. With state-of-the-art technology improvements and compact design, LED lights provide you with many benefits.

Since the luminous efficacy of LED is 4-5 times better than that of halogen, LED needs less power to reach the same optical performance, resulting in less fuel consumption.

Tungsramp LED Retrofit Headlights provide a stylish look together with superior brightness, additionally they are designed to have a removable optical disc, making installation easy.

Make sure to check headlamp dimensional requirements on the product packaging before installing.

In many countries LED Retrofit headlight lamps can ONLY BE USED OFF-ROAD, so before fitting them in your car, please always check your local regulations.

## Megalight LED Gen II

NEW

Up to **230% more light** ahead compared to halogen minimum legal requirements

Crisp bright light with 6000K colour temperature provides superior visibility.

Stable light output and color temperature with excellent heat pipe temperature control.

Premium projected light quality – best vision yet minimal glare.

Compact design with integrated driver. Great fitting to small places.



## 12/24V

### LED Retrofit Headlight lamps

Type	REPLACEMENT	CCT (K)	W			Fig.	SKU	EAN	
<b>Megalight Gen II</b>									
61400	H1	6000	20	P14,5s	PB2	1/4/24 set	1	93120749	5994100094401
61410	H4	6000	20/20	P43t	PB2	1/4/24 set	2	93120752	5994100094388
61420	H7	6000	20	PX26d	PB2	1/4/24 set	3	93120753	5994100094395
61430	H8/H9/H11/H16	6000	20	PGJ19	PB2	1/4/24 set	4	93120750	5994100094616
61440	HB3/HB4	6000	20	P20d/P22d	PB2	1/4/24 set	5	93120751	5994100094371

For 12V and 24V systems. Operation voltage 11-30V.

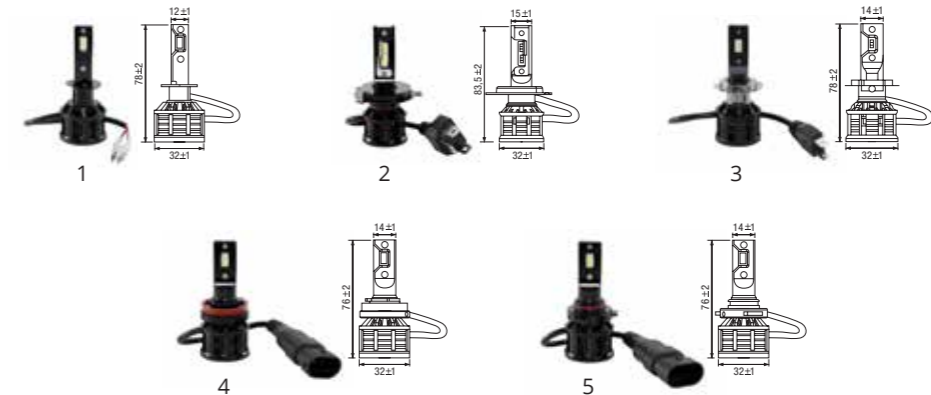

Up to 230% more light ahead

### Warning canceller

Type	W	Fig.	SKU	EAN
Canbus	55 B1 1/4	6	93117210	5994100056829

Canbus is needed only if a warning signal is activated or lamp operates irregularly. Canbus type is dependent on the traditional lamp wattage.

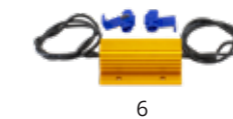

### Jusqu'à 230% de lumière en plus par rapport aux exigences légales minimales pour les halogènes.

- Une lumière vive et nette, avec une température de couleur de 6000K, qui offre une visibilité supérieure.
- Rendement lumineux et température de couleur stables avec un excellent contrôle de la température du caloduc.
- Qualité supérieure de la lumière projetée - meilleure vision avec un éblouissement minimal.
- Conception compacte avec pilote intégré. S'adapte parfaitement aux petits espaces.



### Bis zu 230 % mehr Licht nach vorne im Vergleich zu den gesetzlichen Mindestanforderungen für Halogen.

- Gestochen scharfes & helles Licht mit 6000K Farbtemperatur bietet hervorragende Sichtbarkeit.
- Stabile Lichtleistung und Farbtemperatur mit intern leistungsfähiger Temperaturkontrolle.
- Erstklassige Qualität des projizierten Lichts – beste Sicht bei minimaler Blendung.
- Kompaktes Design mit integriertem Treiber für eine einfache Installation an engen Stellen.



### Hasta un 230% más de luz delantera en comparación con los requisitos legales mínimos para halógenos.

- La luz brillante y nítida con una temperatura de color de 6000K proporciona una visibilidad superior.
- Salida de luz y temperatura de color estables con excelente control de temperatura del tubo térmico.
- Calidad de luz proyectada premium: mejor visión y deslumbramiento mínimo.
- Diseño compacto con controlador integrado. Ideal para lugares pequeños.



### Fino al 230% di luce in più rispetto ai requisiti minimi di legge sulle lampade alogene.

- La luce brillante e nitida con temperatura di colore di 6000K offre una visibilità superiore.
- Emissione luminosa e temperatura di colore stabili con eccellente controllo della temperatura del tubo di riscaldamento.
- Qualità premium della luce proiettata: migliore visione e minimo abbagliamento.
- Design compatto con driver integrato. Si adatta benissimo ai piccoli luoghi.



# LED Retrofit Headlight lamps

## Megalight LED +200 Megalight LED +150

Up to **150/200% more light** ahead compared to halogen minimum legal requirements.

Crisp bright light with 6000K colour temperature provides superior visibility.  
Option of passive or active cooling to best fit your application.  
Operates on 12V systems.



**Jusqu'à 150/200% de lumière en plus par rapport aux exigences légales minimales pour les halogènes.**

- Une lumière vive et nette, avec une température de couleur de 6000K, qui offre une visibilité supérieure.
- Option de refroidissement passif ou actif qui s'intègre mieux à votre application.
- Fonctionne sur les systèmes 12V.



**Bis zu 150/200 % mehr Licht nach vorne im Vergleich zu den gesetzlichen Mindestanforderungen für Halogen.**

- Gestochen scharfes helles Licht mit 6000K Farbtemperatur bietet hervorragende Sichtbarkeit.
- Wahlweise passive oder aktive Kühlung, passend für Ihr Fahrzeug.
- Funktioniert mit 12V Systemen.



**Hasta un 150/200% más de luz delantera en comparación con los requisitos legales mínimos para halógenos.**

- La luz brillante y nítida con una temperatura de color de 6000K proporciona una visibilidad superior.
- Opción de enfriamiento pasivo o activo para adaptarse mejor a su aplicación.
- Funciona con sistemas de 12V.



**Fino al 150/200% di luce in più rispetto ai requisiti minimi di legge sulle lampade alogene.**

- La luce brillante e nitida con temperatura di colore di 6000K offre una visibilità superiore.
- Possibilità di raffreddamento passivo o attivo per adattarsi al meglio.
- Funzionamento con sistemi a 12V.

OFF ROAD



## 12V

### LED Retrofit Headlight lamps

Type	REPLACEMENT	CCT (K)	W	Icon 1	Icon 2	Fig.	SKU	EAN	
<b>Megalight LED +200</b>									
60410	H1	6000	24	P14,5s	PB2	1/4/24 set	1	93115660	5994100044260
60430	H4	6000	24/24	P43t	PB2	1/4/24 set	2	93115173	5994100036173
60450	H7	6000	24	PX26d	PB2	1/4/24 set	3	93115175	5994100036197
60490	H8/H11	6000	24	PGJ19-1/2	PB2	1/4/24 set	4	93115662	5994100044284
60530	HB3	6000	24	P20d	PB2	1/4/24 set	5	93115664	5994100044307
60550	HB4	6000	24	P22d	PB2	1/4/24 set	6	93115676	5994100044529

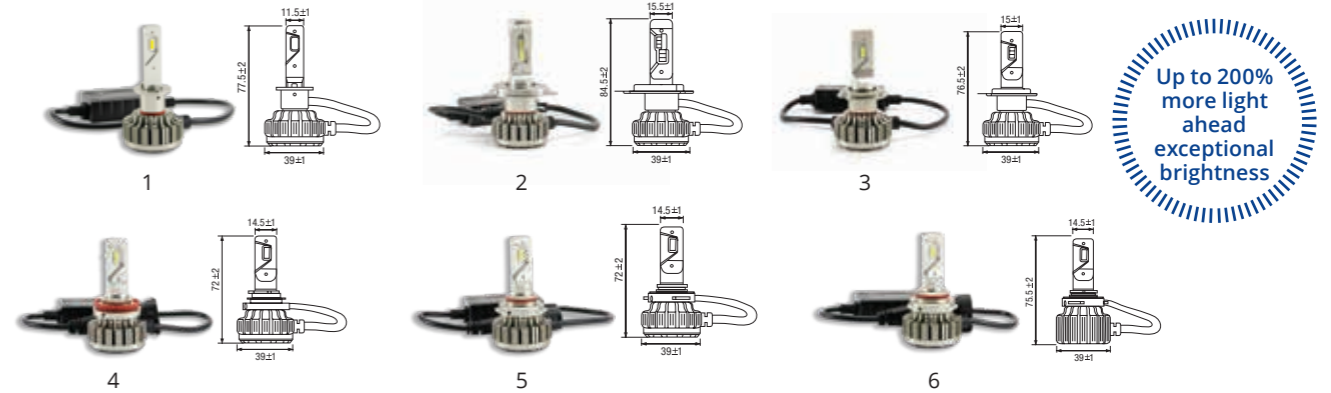

Up to 200% more light ahead exceptional brightness

### LED Retrofit Headlight lamps

Type	REPLACEMENT	CCT (K)	W	Icon 1	Icon 2	Fig.	SKU	EAN	
<b>Megalight LED +150</b>									
60400	H1	6000	18	P14,5s	PB2	1/4/24 set	7	93115659	5994100044253
60420	H4	6000	18/18	P43t	PB2	1/4/24 set	8	93115172	5994100036166
60440	H7	6000	18	PX26d	PB2	1/4/24 set	9	93115174	5994100036180
60480	H8/H11	6000	18	PGJ19-1/2	PB2	1/4/24 set	10	93115661	5994100044277
60520	HB3	6000	18	P20d	PB2	1/4/24 set	11	93115663	5994100044291
60540	HB4	6000	18	P22d	PB2	1/4/24 set	12	93115665	5994100044512

For 12V system. Operation voltage 10-20V.

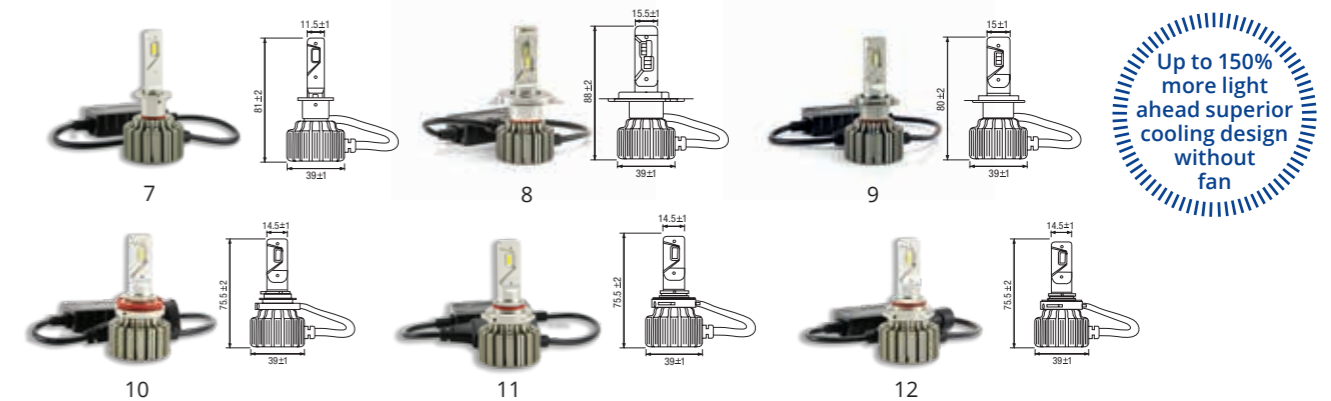

Up to 150% more light ahead superior cooling design without fan

### Warning canceller

Type	W	Icon 1	Fig.	SKU	EAN
Canbus	55	B1	1/4	93117210	5994100056829

Canbus is needed only if a warning signal is activated or lamp operates irregularly.  
Canbus type is dependent on the traditional lamp wattage.



13



# LED Retrofit Miniature lamps

## Brighter, long lasting alternatives to traditional bulbs

Produces a white, brighter light, ideal for improving the look of a vehicle.

Energy saving and long lasting compared to incandescent bulbs.

Internal or off-road external use only.



### Alternatives plus lumineuses et durables comparées aux ampoules traditionnelles

- Produit une lumière blanche et plus brillante, idéale pour améliorer l'apparence d'un véhicule.
- Économie d'énergie et longue durée par rapport aux lampes incandescentes.
- Usage interne ou externe hors route uniquement.



### Hellere und langlebigere Alternativen zu herkömmlichen Lampen

- Erzeugt ein weißes, helleres Licht, ideal um das Aussehen des Fahrzeugs zu verbessern.
- Energiesparend und langlebiger im Vergleich zu herkömmlichen Glühlampen.
- Für die Verwendung im Kfz-Innenraum oder externe Anwendungen ohne Straßenzulassung.



### Alternativas más brillantes y duraderas a las lámparas tradicionales

- Refleja una luz blanca más brillante, ideal para mejorar la vision del vehículo.
- Ahorro de energía y larga duración en comparación con lámparas incandescentes.
- De uso exclusivo para interior del vehículo o en vías no oficiales.



### Alternative più luminose e durature alle lampade tradizionali

- Luce bianca, più luminosa, ideale per migliorare l'aspetto della vostra auto.
- Risparmio energetico e maggiore durata rispetto alle lampadine ad incandescenza.
- Esclusivamente per uso interno abitacolo ed "off road".



# 12V

## LED Retrofit Miniature lamps

Type	REPLACEMENT	CCT (K)	V	W	Fig.	SKU	EAN	CANBUS TYPE	
60140	W3W, W5W	4000	12	0.5	W2.1x9.5d	BL1 1/10	1	93118393 5994100072546	5W
60200	C5W	4000	12	0.5	SV8.5-8	BL1 1/10	2	93108744 5994100010258	5W
60210	DIN72601K	4000	12	0.5	SV8.5-8	BL1 1/10	3	93095655 5994100006909	5W
60570	Festoon 28mm	4000	12	0.7	SV7	BL1 1/10	4	93116981 5994100054276	5W
60590	Festoon 31mm	4000	12	0.7	SV8.5-8	BL1 1/10	5	93116983 5994100054290	5W
60630	P21W	4000	12	3	Ba15s	BL1 1/10	6	93116985 5994100054818	21W
60650	P21/5W	4000	12	3/0.55	BAY15d	BL1 1/10	7	93117017 5994100054832	Main: 21W Minor: 5W
60690	W21W	4000	12	3	W3x16d	BL1 1/10	8	93117021 5994100054870	21W
60710	W21/5W	4000	12	3/0.55	W3x16q	BL1 1/10	9	93117023 5994100054894	Main: 21W Minor: 5W
60790	M5	4000	12	5	P15d-25-1	BL1 1/10	10	93117031 5994100054979	21W
60170	W3W, W5W	6000	12	0.5	W2.1x9.5d	BL1 1/10	1	93118392 5994100072539	5W
60230	C5W	6000	12	0.5	SV8.5-8	BL1 1/10	2	93108743 5994100011934	5W
60240	DIN72601K	6000	12	0.5	SV8.5-8	BL1 1/10	3	93095654 5994100006916	5W
60560	Festoon 28mm	6000	12	0.7	SV7	BL1 1/10	4	93116980 5994100054269	5W
60580	Festoon 31mm	6000	12	0.7	SV8.5-8	BL1 1/10	5	93116982 5994100054283	5W
60620	P21W	6000	12	3	Ba15s	BL1 1/10	6	93116984 5994100054306	21W
60640	P21/5W	6000	12	3/0.55	BAY15d	BL1 1/10	7	93117016 5994100054825	Main: 21W Minor: 5W
60680	W21W	6000	12	3	W3x16d	BL1 1/10	8	93117020 5994100054863	21W
60700	W21/5W	6000	12	3/0.55	W3x16q	BL1 1/10	9	93117022 5994100054887	Main: 21W Minor: 5W
60780	M5	6000	12	5	P15d-25-1	BL1 1/10	10	93117030 5994100054962	21W
60870	W16W	6000	12	2	W2.1x9.5d	BL1 1/10	11	93120767 5994100094340	21W
60660	P21W	RED	12	3	Ba15s	BL1 1/10	12	93117018 5994100054849	21W
60670	P21/5W	RED	12	3/0.55	BAY15d	BL1 1/10	13	93117019 5994100054856	Main: 21W Minor: 5W
60720	W21W	RED	12	3	W3x16d	BL1 1/10	14	93117024 5994100054900	21W
60730	W21/5W	RED	12	3/0.55	W3x16q	BL1 1/10	15	93117025 5994100054917	Main: 21W Minor: 5W
60930	PY21W	Amber	12/24	2.3	BAU15s	BL1 1/10	16	93120755 5994100094357	21W
60950	WY21W	Amber	12/24	2.3	W3x16d	BL1 1/10	17	93120766 5994100094364	21W
60980	WY5W	Amber	12	0.5	W2.1x9.5d	BL1 1/10	18	93120754 5994100094333	5W

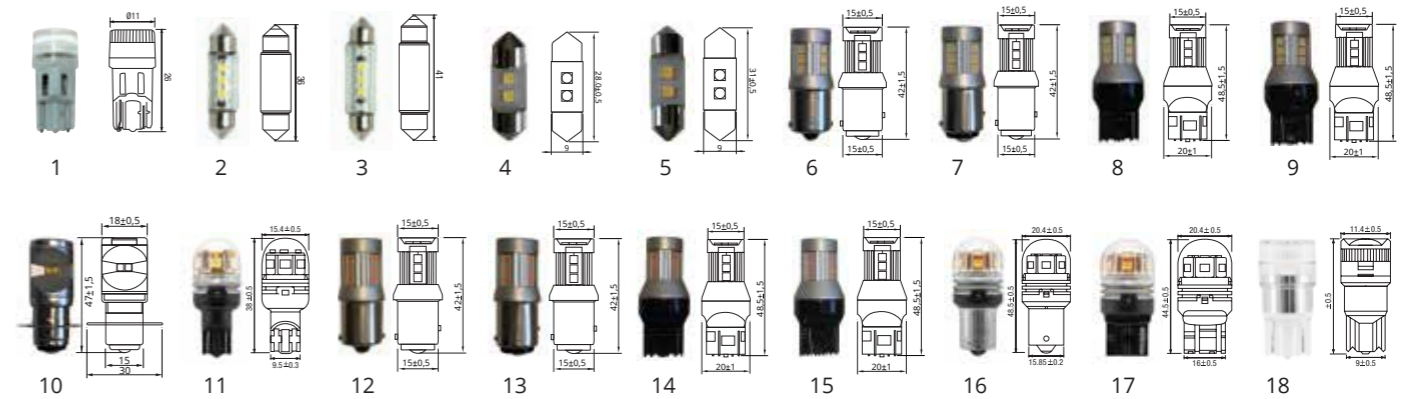

## Warning canceller

Type	W	Fig.	SKU	EAN
Canbus	5	B1 1/4	19	93117208 5994100056805
Canbus	21	B1 1/4	20	93117209 5994100056812

Canbus is needed only if a warning signal is activated or lamp operates irregularly. Canbus type is dependent on the traditional lamp wattage

Cette ampoule LED est prévue pour une utilisation intérieur uniquement.  
Diese LED-Leuchten sind ausschließlich für die Benutzung im Innenbereich vorgesehen.  
Estas lámparas LED son solo para uso interior.  
Questa lampadina al LED é esclusivamente per uso interno.





# Xenon High Intensity Discharge lamps

Tungsramp Xenosion lamps provide a major leap in road safety over conventional halogen lamps due to enormous increase in the illuminated field of vision

Better visibility and illumination provide the driver with many benefits. It assists the human eye and allows better visibility and improved hazard awareness, allowing the driver to navigate poor driving conditions with increased confidence and with less fatigue.

Optically advantageous whiter light compared to halogen lamps designed to give a colour that is closer to natural daylight.

White Xenosion 5500 Kelvin\*

Xenosion Megalight +100

Further improvement in color - light up the road with style and brilliant white light

Add safety to your driving with more light. Up to 100% more light on the road ahead.

Produces a crisp, bright light that is closer to daylight. Up to 20% more light on the road ahead.

Excellent visibility and illumination, greater illuminated area.

\* Colour temperature exceeds 5500K in majority of lifetime.

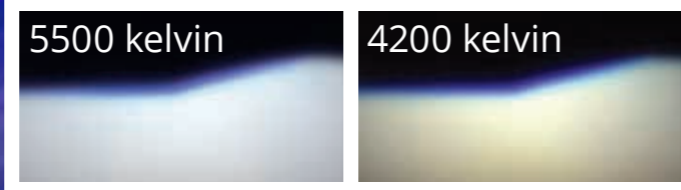

# D1S, D1R, D2S, D2R, D3S, D3R, D4S, D4R

PREMIUM

## Xenon High Intensity Discharge lamps

ECE	Type	Fig.	SKU	EAN
<b>Basic types</b>				
D1S	53620U	B1 1/4/12	35 PK32d-2	1 93106982 5994100012245
D1R	53740U	B1 1/4/12	35 PK32D-3	2 93106977 5994100012306
D2S	53500U	B1 1/3/12	35 P32d-2	3 93106979 5994100012214
D2R	53510U	B1 1/3/12	35 P32d-3	4 93106978 5994100012207
D3S	53660U	B1 1/4/12	35 PK32d-5	1 93095512 5994100006930
D3R	53730U	B1 1/4/12	35 PK32d-6	2 93106976 5994100012290
D4S	53670U	B1 1/3/12	35 P32d-5	3 93095513 5994100006947
D4R	53680U	B1 1/3/12	35 P32d-6	4 93106564 5994100012283
<b>White Xenosion 5500 Kelvin*</b>				
D1S	53750U	B1 1/4/12	35 PK32d-2	1 93096783 5994100007418
D2S	53760U	B1 1/3/12	35 P32d-2	3 93095970 5994100006954
D2R	53770U	B1 1/3/12	35 P32d-3	4 93095514 5994100006961
D3S	53780U	B1 1/4/12	35 PK32d-5	1 93095511 5994100006978
D4S	53790U	B1 1/3/12	35 P32d-5	3 93095510 5994100006985
<b>Megalight +100</b>				
D1S	53620CMU	B1 1/4/12	35 PK32d-2	1 93093630 5994100006886
D2S	53500CMU	B1 1/3/12	35 P32d-2	3 93093633 5994100006893
D3S	53660CMU	B1 1/4/12	35 PK32d-5	1 93117214 5994100056850
D4S	53670CMU	B1 1/3/12	35 P32d-5	3 93117215 5994100056867

\* Colour temperature exceeds 5500K in majority of lifetime.

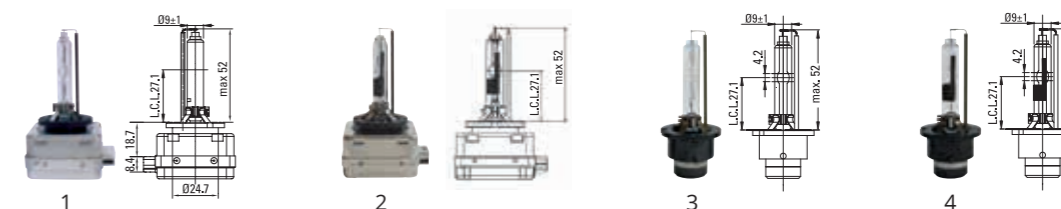

### Xenon Lentille à décharge à haute densité

- Une meilleure visibilité et un meilleur éclairage procurent au conducteur de nombreux avantages.
- **White Xenosion lamps 5500K** illuminent la route avec style et lumière blanche brillante proche de la lumière du jour.
  - **Megalight +100 lamps** ajoutent de la sécurité à votre conduite, apportent jusqu'à 100% plus de lumière sur la route en avant. Excellente visibilité et éclairage, zone éclairée plus grande.



### Lámparas de descarga de xenón con alta intensidad

- Una mejor visibilidad e iluminación que proporcionan al conductor muchas ventajas.
- **Las lámparas Xenosion White con 5500 Kelvin** iluminan la carretera con una luz blanca brillante de manera elegante como si fuera luz natural, ofreciendo hasta un 20% más de luminosidad en la visión frontal de la carretera.
  - **Las lámparas Megalight +100** añaden seguridad a la conducción, ofreciendo hasta un 100% más de luminosidad en la visión frontal de la carretera. Una visibilidad e iluminación excelente, una mayor área iluminada.



### Xenon High Intensity Entladungslampen

- Bessere Sichtbarkeit und Ausleuchtung bieten dem Fahrer viele Vorteile.
- **Weißer Xenosion-Lampen 5500K** beleuchten die Straße mit Stil und strahlendem weißem Licht, das sich dem Tageslicht annähert, und bieten bis zu 20% mehr Licht auf der Straße.
  - **Megalight +100 Lampen** sorgen für mehr Sicherheit beim Fahren und bieten bis zu 100% mehr Licht auf der Straße. Hervorragende Sichtbarkeit und Ausleuchtung, größere Beleuchtungsfläche.



### Lampadine a scarica ad alta intensità allo Xenon

- Una migliore visibilità e illuminazione forniscono al conducente numerosi vantaggi.
- **Le lampadine White Xenosion 5500K** illuminano la strada con stile e con una luce bianca brillante vicina alla luce del giorno, fornendo fino al 20% di luce in più sulla strada da percorrere.
  - **Le lampadine Megalight +100 lamps** aggiungono sicurezza alla guida, offrendo fino al 100% di luce in più sulla strada da percorrere. Ottima visibilità ed illuminazione, maggiore area illuminata.



# Halogen headlight lamps

lighting your way...

As well as the basic range, Tungsram automotive also offers the premium range, based on special lamp designs. The premium range includes: Megalight Ultra, Megalight Plus, Sportlight, Long Life, Heavy Star, Rally. The premium lamps have additional benefits in terms of life, colour, vibration resistance or wattage.

The premium lamps are also E1 marked, making their use on the EU roads possible, with the exception of Rally lamps that were designed for off-road usage. Long Life lamps have enhanced life, Megalight Plus and Ultra lamps possess increased luminance, Sportlight halogen lamps give intense blue-white light.

**UPGRADE YOUR CAR WITH TUNGSRAM PREMIUM LAMPS**

	H1	H3	H4	H7	H11	HB3	HB4
Megalight Ultra +200			●	●			
Megalight Ultra +150	●		●	●	●		
Megalight Ultra +130	●		●	●	●		
Megalight Ultra +120	●		●	●	●	●	●
Megalight Ultra +90	●		●	●	●	●	●
Megalight Plus	●		●	●			
Sportlight Extreme	●		●	●	●		
Sportlight Ultra	●		●	●	●	●	●
Sportlight	●		●	●		●	●
Long Life	●	●	●	●			
Heavy Star	●	●	●	●			
Rally	●	●	●	●			



## MEGALIGHT RANGES

STANDARD LAMPS	MEGALIGHT ULTRA +200	MEGALIGHT ULTRA +150	MEGALIGHT ULTRA +130	MEGALIGHT ULTRA +120	MEGALIGHT ULTRA +90	MEGALIGHT PLUS 50-60
----------------	----------------------	----------------------	----------------------	----------------------	---------------------	----------------------

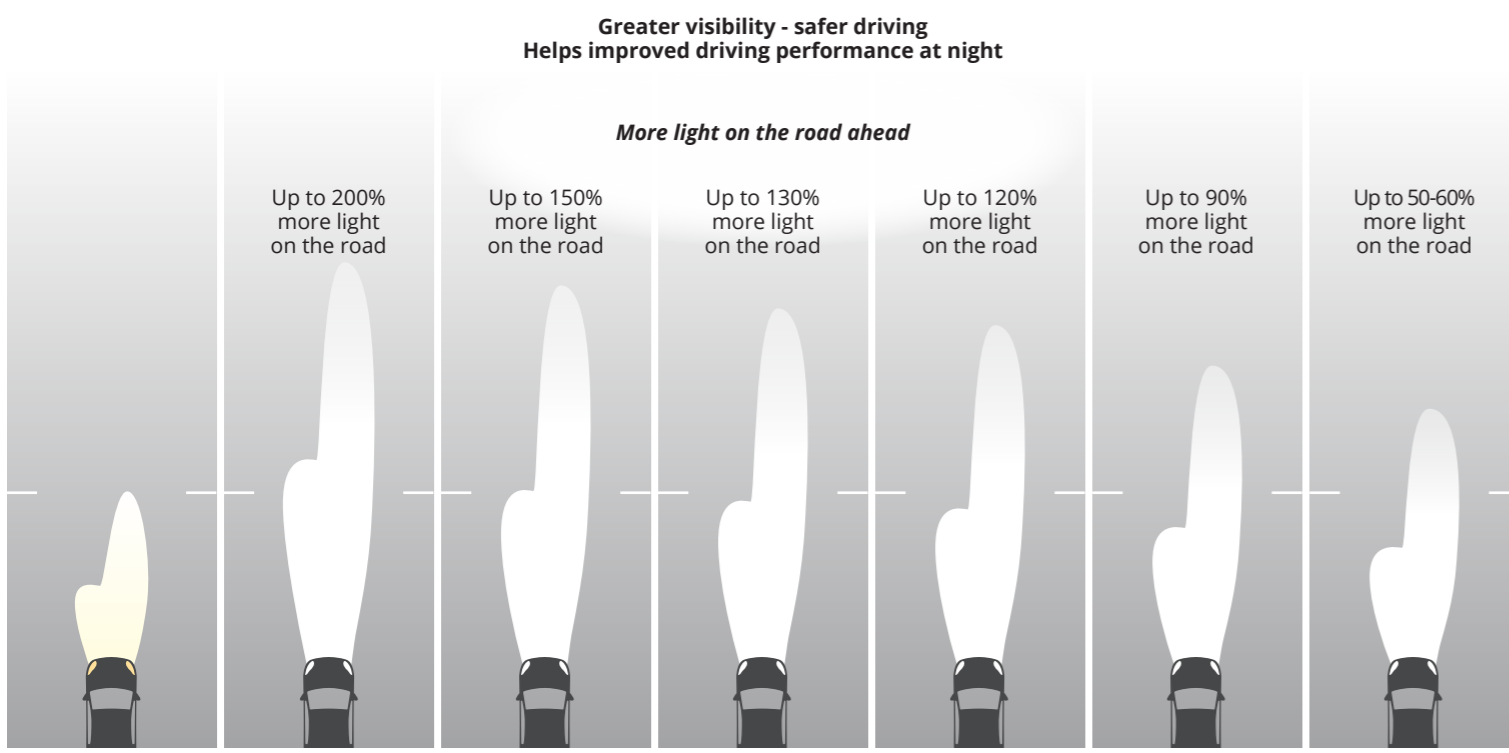

## SPORTLIGHT RANGES

SPORTLIGHT EXTREME	SPORTLIGHT ULTRA	SPORTLIGHT	LONG LIFE	HEAVY STAR	RALLY
--------------------	------------------	------------	-----------	------------	-------

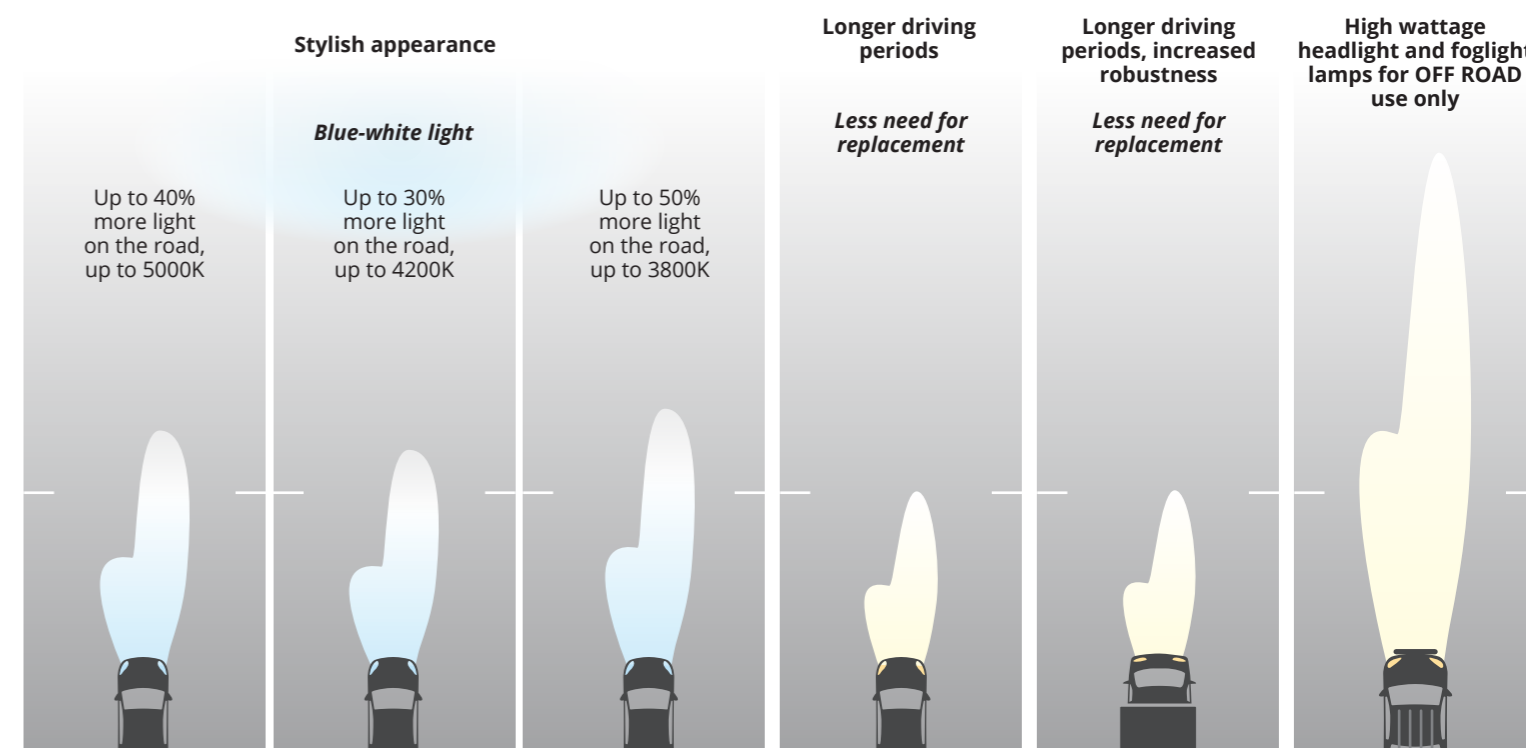



# Megalight Ultra +200



More Light



Greater visibility

STREET LEGAL

## Up to 200% more light on the road

Driving safety without compromise.

Ultimate performance – up to 200% more light on the road ahead.

Brightest halogen light in our range – meets and exceeds the highest performance levels.

A design to perform with fine adjustment of filaments, 100% xenon gas fill and special coating system.

Silver top gives an attractive appearance, especially in clear lens reflector headlamps.



## 12V

### Megalight Ultra +200 - Halogen headlight lamps

ECE	Type	Box	T <sub>c</sub>	W	Fig.	SKU	EAN	
H4	50440XHU	B2	250	60/55	P43t	1	93120596	5994100090984
		PB2					1/5 set	93120535
H7	58520XHU	B2	250	55	PX26d	2	93120599	5994100091318
		PB2					1/5 set	93120598

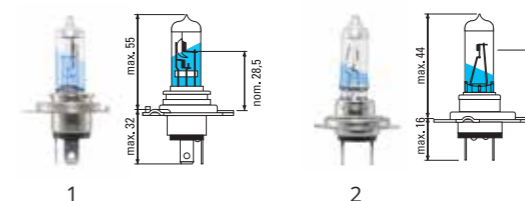

Always change the headlamps by pair.



### Jusqu'à 200% plus de lumière sur la route

- La sécurité de conduite sans compromis
- Performance de pointe - jusqu'à 200 % de lumière en plus sur la route
- La lampe halogène la plus brillante de notre gamme - atteint et dépasse les niveaux de performance les plus élevés.
- Une conception qui augmente la performance grâce à un réglage fin des filaments, un remplissage à 100% avec du gaz xénon et un système de revêtement spécial.
- Le dessus en argent donne un aspect attrayant, particulièrement dans les projecteurs à réflecteur avec des lentilles clair.



### Bis zu 200% mehr Licht auf der Straße

- Fahrsicherheit ohne Kompromisse
- Ultimative Leistung – bis zu 200 % mehr Licht auf der Straße
- Hellste Halogenscheinwerferlampe in unserem Sortiment - erfüllt und übertrifft die höchsten Leistungsniveaus.
- Ein leistungsstarkes Design mit Feinabstimmung des Drahtes, 100% Xenon-Gasfüllung und speziellem Beschichtungssystem.
- Der silberne Abschluss sorgt für ein attraktives Erscheinungsbild, insbesondere bei Scheinwerfern mit klaren Linsenreflektoren.



### Hasta un 200% más de luz en la carretera

- Seguridad de conducción sin compromisos
- Máximo rendimiento: hasta un 200% más de luz en la carretera
- Lámparas halógenas para faros más brillantes que superan ampliamente los niveles más exigentes de rendimiento.
- Un diseño realizado con un fino ajuste de los filamentos, relleno de gas xenón 100% y un sistema de recubrimiento especial.
- La parte superior plateada le da un aspecto atractivo, especialmente en los faros con reflector de lente transparente.



### Fino al 200% di luce in più sulla strada davanti a Voi

- Guida sicura senza compromessi
- Massime prestazioni - fino al 200% di luce in più sulla strada davanti a Voi
- La luce alogena più brillante della nostra gamma - soddisfa e supera i più alti livelli di prestazione.
- Una progettazione realizzata con regolazione fine dei filamenti, riempimento di gas xeno al 100% e sistema di rivestimento speciale.
- La parte superiore in argento conferisce un aspetto accattivante, in particolare nei fari con riflettori aventi lente trasparente.

T<sub>c</sub> (HOUR) is the time up to which 63,2 % of tested lamps have ended their lives. Measured according to Tungsram life test specification. The life of the lamp is sensitive to the operation voltage of the car, 1% of change of the voltage results in 12-15% change of life with opposite sign.

# Megalight Ultra +150



More Light



Greater visibility

STREET LEGAL

## SEE even MORE - up to **150%** more light on the road

100% xenon gas fill.

Drive safely with superior performance.

Safer, easier night driving, with better reflections from road markings and signs

The greater illumination combined with whiter light resulting from the blue partial coating add safety to your driving - especially advantageous for fatigued drivers.

Silver top gives an attractive appearance, especially in clear lens reflector headlamps.



# 12V

## Megalight Ultra +150 - Halogen headlight lamps

ECE	Type	Fig.	T <sub>c</sub>	W	Fig.	SKU	EAN		
H1	59010NXNU	B2	1/9 set	250	55	P14,5s	1	93116890	5994100053552
		PB2	1/5 set				1	93116876	5994100053545
H4	50440NXNU	B2	1/9 set	250	60/55	P43t	2	93100448	5994100008118
		PB2	1/5 set				2	93088612	5994100006831
H7	58520NXNU	B2	1/9 set	250	55	PX26d	3	93100449	5994100008125
		PB2	1/5 set				3	93088611	5994100006817
H11	53110NXNU	B2	1/9 set	250	55	PGJ19-2	4	93116891	5994100053569
		PB2	1/5 set				4	93116877	5994100053415

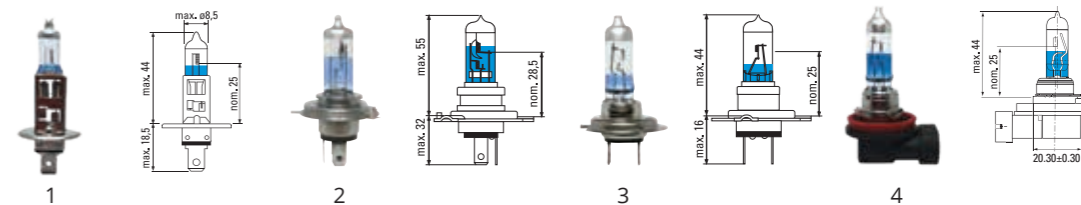

Always change the headlamps by pair.



### Voir encore plus - jusqu' à 150% plus de lumière sur les routes

- 100% de gas xénon
- Conduisez en toute sécurité avec des performances supérieures.
- Conduite de nuit plus sûre et plus facile avec de meilleures réflexions des marquages routiers et des panneaux.
- La plus grande illumination combinée avec une lumière plus blanche résultant du revêtement partiel bleu, ajouter la sécurité à votre conduite - particulièrement avantageux pour les conducteurs fatigués.
- Le dessus en argent donne un aspect attrayant, particulièrement dans les projecteurs à réflecteur avec des lentilles clair.



### SEHEN SIE noch MEHR - bis zu 150% mehr Licht auf der Straße

- 100% Xenon-Füllgas.
- Fahren Sie sicher mit überlegener Leistung.
- Sicherere und einfachere Nachtfahrten mit besseren Reflexionen von Straßenmarkierungen und Schildern.
- Die stärkere Ausleuchtung und das weißere, durch die blaue partielle Beschichtung entstehende Licht erhöhen die Sicherheit beim Fahren - besonders vorteilhaft für ermüdete Fahrer.
- Die silberne Oberseite sorgt für ein attraktives Erscheinungsbild, insbesondere bei Scheinwerfern mit klarem Linsenreflektor.



### VEA mucho MÁS: Ofrece hasta un 150% más de luz en carretera

- 100% rellena con gas xenón.
- Conduzca de forma segura con un rendimiento superior.
- Conducción nocturna más segura que facilita una mejor visualización de las señales de tránsito así como las marcadas en el asfalto.
- Una mayor iluminación que combina una luz más blanca gracias al recubrimiento parcial en azul que agrega seguridad en la conducción, especialmente en los momentos que el conductor está fatigado.
- La parte superior plateada le da un aspecto atractivo, especialmente en los faros con reflector de lente transparente.



### Maggiore visibilità: fino al 150% di luce in più sulla strada

- Riempimento con gas Xenon al 100%.
- Ottime prestazioni per una guida sicura.
- Guida notturna più sicura e agevole con riflessi migliori provenienti dalla segnaletica orizzontale e verticale.
- L'illuminazione maggiore, insieme a una luce più bianca data dal parziale rivestimento blu, aggiungono sicurezza alla guida, soprattutto nei momenti di maggior stanchezza.
- La parte superiore in argento conferisce un aspetto accattivante, in particolare nei fari con riflettore a lente trasparente.

T<sub>c</sub> (HOUR) is the time up to which 63,2 % of tested lamps have ended their lives. Measured according to Tungsram life test specification. The life of the lamp is sensitive to the operation voltage of the car, 1% of change of the voltage results in 12-15% change of life with opposite sign.



# Megalight Ultra +130



More Light



Greater visibility

STREET LEGAL

## Up to **130%** more light on the road

A further step in illumination of the road ahead.

Generates more light on the road by optimized filament design with 100% xenon fill and specialized coating system.

Silver top gives an attractive appearance, especially in clear lens reflector headlamps.



# 12V

## Megalight Ultra +130 - Halogen headlight lamps

ECE	Type	Diagram	T <sub>c</sub>	W	Fig.	SKU	EAN			
H1	50310XNU	B2	250	55	P14,5s	1	93108046	5994100020165		
		PB2					1/5 set	1	93116872	5994100053538
		BL2					1/10 set	1	93108040	5994100020158
H4	50440XNU	B2	250	60/55	P43t	2	93108045	5994100020288		
		PB2					1/5 set	2	93116873	5994100053453
		BL2					1/10 set	2	93108039	5994100020271
H7	58520XNU	B2	250	55	PX26d	3	93108044	5994100020417		
		PB2					1/5 set	3	93116874	5994100053491
		BL2					1/10 set	3	93108038	5994100020400
H11	53110XNU	B2	250	55	PGJ19-2	4	93111388	5994100029250		
		PB2					1/5 set	4	93116875	5994100053378

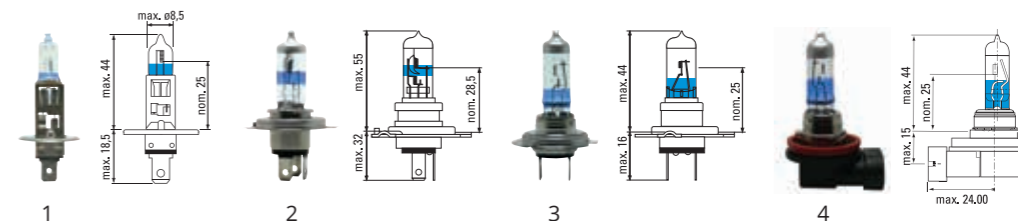

Always change the headlamps by pair.



### Jusqu'à 130% plus de lumière sur la route

- Une nouvelle étape dans l'éclairage de la route.
- Génère plus de lumière sur la route grâce à une conception de filament optimisée avec 100% de xénon et système de revêtement spécialisée.
- Le plateau argenté donne un aspect attrayant, en particulier dans les projecteurs à réflecteur à objectif transparent.



### Bis zu 130% mehr Licht auf der Straße

- Ein weiterer Schritt in der Beleuchtung der Straße.
- Erzeugt mehr Licht auf der Straße durch ihr optimiertes Glühfadendesign mit 100% Xenonfüllung und speziellem Beschichtungssystem.
- Die silberne Oberseite sorgt für ein attraktives Erscheinungsbild, insbesondere bei Scheinwerfern mit klarem Linsenreflektor.



### Ofrece hasta un 130% más de iluminación en la carretera

- Un paso adelante en términos de iluminación en la visión frontal de la carretera.
- Genera más emisión de luz en la carretera a través de un diseño de filamentos optimizados 100% relleno con xenón y con un sistema de recubrimiento especial.
- La parte superior plateada le da un aspecto atractivo, especialmente en los faros con reflector de lente transparente.



### Fino al 130% di luce in più sulla strada

- Un ulteriore passo nell'illuminazione della strada da percorrere.
- Genera più luce sulla strada grazie al design ottimizzato del filamento con riempimento di gas Xenon al 100% e al sistema di rivestimento speciale.
- La parte superiore in argento conferisce un aspetto accattivante, in particolare nei proiettori con riflettori a lente trasparente.

**T<sub>c</sub> (HOUR)** is the time up to which 63,2 % of tested lamps have ended their lives. Measured according to Tungsram life test specification. The life of the lamp is sensitive to the operation voltage of the car, 1% of change of the voltage results in 12-15% change of life with opposite sign.

# Megalight Ultra +120



More Light



Greater visibility

STREET LEGAL

## Up to 120% more light on the road

Intense and powerful lamp in terms of luminance, for safer driving 100% xenon gas fill.

Improved headlamp illumination level helps in reduction of accidents at night time/in poor visibility conditions.

Silver top gives an attractive appearance, especially in clear lens reflector headlamps.



## 12V

### Megalight Ultra +120 - Halogen headlight lamps

ECE	Type	Fig.	T <sub>c</sub>	W	Fig.	SKU	EAN		
H1	50310NU	B2 1/9 set	250	55	P14,5s	1	93098621	5994100007043	
		PB2 1/5 set					1	93116868	5994100053521
		BL2 1/10 set					1	93105797	5994100010036
H4	50440SNU	B2 1/9 set	250	60/55	P43t	2	93098620	5994100007050	
		PB2 1/5 set					2	93116867	5994100053439
		BL2 1/10 set					2	93108033	5994100020240
H7	58520SNU	B2 1/9 set	250	55	PX26d	3	93098619	5994100007067	
		PB2 1/5 set					3	93116866	5994100053484
		BL2 1/10 set					3	93108034	5994100020363
H11	53110SNU	B2 1/9 set	250	55	PGJ19-2	4	93098622	5994100007036	
		PB2 1/5 set					4	93116869	5994100053347
HB3	9005NU	B2 1/9 set	200	60	P20d	5	93098625	5994100007012	
		PB2 1/5 set					5	93116871	5994100053361
HB4	9006SNU	B2 1/9 set	250	51	P22d	6	93098623	5994100007029	
		PB2 1/5 set					6	93116870	5994100053354

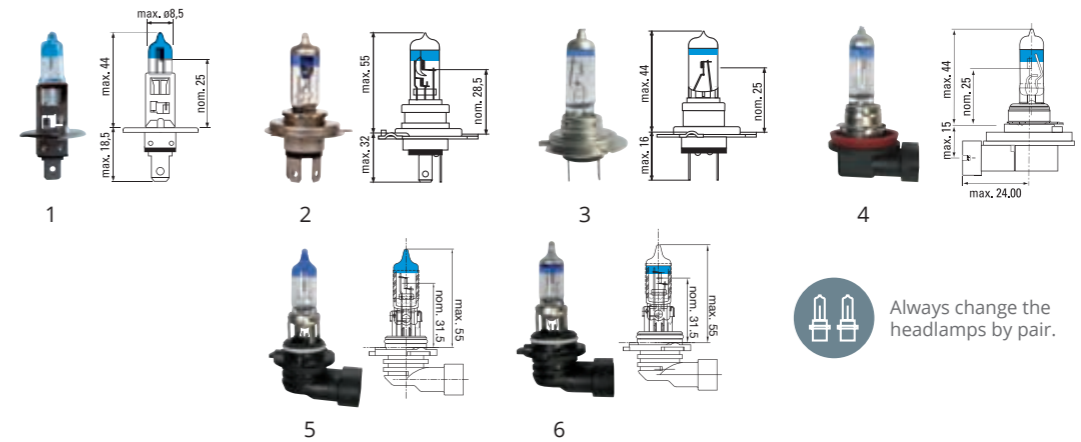

### Jusqu'à 120% plus de lumière sur les routes

- Lampe intense et puissante en termes de luminance, pour une conduite plus sûre 100% de gas xénon.
- Un meilleur niveau d'éclairage des phares contribue à réduire les accidents pendant la nuit/dans de mauvaises conditions de visibilité.
- Le plateau argenté donne un aspect attrayant, en particulier dans les projecteurs à réflecteur à objectif transparent.



### Bis zu 120% mehr Licht auf der Straße

- Intensive und leistungsstarke Lampe in Bezug auf Helligkeit und mit 100% Xenon-Gasfüllung für sicheres Fahren.
- Das verbesserte Beleuchtungsniveau des Scheinwerfers hilft bei der Verringerung der Unfälle in der Nacht/bei schlechten Sichtverhältnissen.
- Die silberne Oberseite sorgt für ein attraktives Erscheinungsbild, insbesondere bei Scheinwerfern mit klarem Linsenreflektor.



### Ofrece hasta un 120% más de luz en carretera

- Lámpara intensa y potente en términos de luminosidad; 100% relleno con gas xenón para obtener una conducción más segura.
- La mejora en el nivel de iluminación de los faros ayuda a reducir los accidentes durante la noche en condiciones de poca visibilidad.
- La parte superior plateada le da un aspecto atractivo, especialmente en los faros con reflector de lente transparente.



### Fino al 120% di luce in più sulla strada

- Lampada intensa e potente in termini di luce irradiata, per una guida più sicura, riempimento con gas allo xeno al 100%.
- Il migliorato livello di illuminazione dei fari aiuta a ridurre gli incidenti notturni e/o in condizioni di scarsa visibilità.
- La parte superiore in argento conferisce un aspetto accattivante, in particolare nei fari con riflettori con lente trasparente.

T<sub>c</sub> (HOUR) is the time up to which 63,2 % of tested lamps have ended their lives. Measured according to Tungsram life test specification. The life of the lamp is sensitive to the operation voltage of the car, 1% of change of the voltage results in 12-15% change of life with opposite sign.



# Megalight Ultra +90



More Light



Greater visibility

12V

PREMIUM

## Up to 90% more light on the road

High performance lamps for visibility, convenience and style.

Improved driving performance at night.

Greater illumination combined with whiter light add safety to your driving.

Silver top gives an attractive appearance, especially in clear lens reflector headlamps.

STREET LEGAL

### Megalight Ultra +90 - Halogen headlight lamps

ECE	Type	Fig.	T <sub>c</sub>	W	Fig.	SKU	EAN	
H1	50310XU	B2	350	55	P14,5s	1	93098494	5994100007203
		PB2				1	93116878	5994100053514
		BL2				1	93108030	5994100020172
H4	50440SXU	B2	350	60/55	P43t	2	93098492	5994100007180
		PB2				2	93116879	5994100053422
		BL2				2	93108027	5994100020264
H7	58520SXU	B2	350	55	PX26d	3	93098493	5994100007197
		PB2				3	93116880	5994100053477
		BL2				3	93108028	5994100020387
H11	53110SXU	B2	350	55	PGJ19-2	4	93098495	5994100006220
		PB2				4	93116881	5994100053316
HB3	9005XU	B2	200	60	P20d	5	93098617	5994100007074
		PB2				5	93116883	5994100053330
HB4	9006SXU	B2	350	51	P22d	6	93098616	5994100007081
		PB2				6	93116882	5994100053323

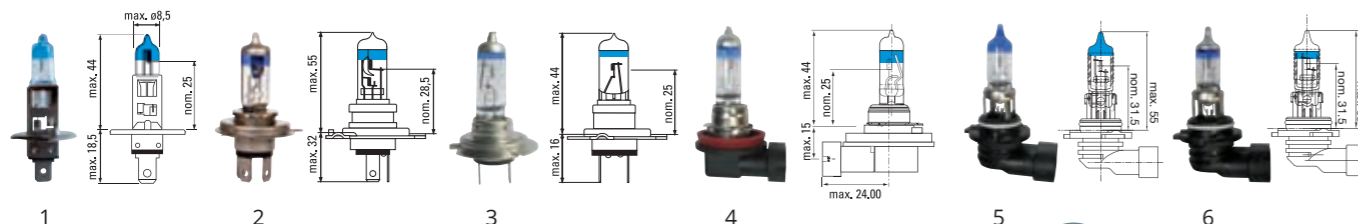

Always change the headlamps by pair.



### Jusqu'à 90% plus de lumière sur les routes

- Lampes haute performance pour la visibilité, confort et style.
- Amélioration des performances de conduite pendant la nuit.
- Plus d'éclairage combiné à une lumière plus blanche, ajouter de la sécurité à votre conduite.
- Le plateau argenté donne un aspect attrayant, en particulier dans les projecteurs à réflecteur à objectif transparent.



### Bis zu 90% mehr Licht auf der Straße

- Hochleistungslampen für Sichtbarkeit, Komfort und Stil
- Verbesserte Fahrleistung in der Nacht.
- Die stärkere Ausleuchtung und das weißere Licht erhöhen die Sicherheit beim Fahren.
- Die silberne Oberseite sorgt für ein attraktives Erscheinungsbild, insbesondere bei Scheinwerfern mit klarem Linsenreflektor.



### Ofrece hasta un 90% más de luz en carretera

- Lámparas de alto rendimiento en cuanto a visibilidad, comodidad y con estilo.
- Para una mejor conducción nocturna.
- Una mejor iluminación combinada con una luz más blanca que agrega seguridad a su conducción.
- La parte superior plateada le da un aspecto atractivo, especialmente en los faros con reflector de lente transparente.



### Fino al 90% di luce in più sulla strada

- Lampade ad alta prestazione per visibilità, praticità e stile.
- Miglioramento delle prestazioni di guida durante la notte.
- Una maggiore illuminazione unita alla luce più bianca aggiungono sicurezza alla guida.
- La parte superiore in argento conferisce un aspetto accattivante, in particolare nei fari con riflettori con lente trasparente.

T<sub>c</sub> (HOUR) is the time up to which 63,2 % of tested lamps have ended their lives. Measured according to Tungsram life test specification. The life of the lamp is sensitive to the operation voltage of the car, 1% of change of the voltage results in 12-15% change of life with opposite sign.

# Megalight Plus 50, 60



More Light



Greater visibility

12V

PREMIUM

## Up to 50-60% more light on the road

Headlight lamps that provide more light when and where you need it most.

STREET LEGAL

### Megalight Plus 50, 60 - Halogen headlight lamps

ECE	Type	Fig.	T <sub>c</sub>	W	Fig.	SKU	EAN	
H1	50310MPU	B2	600	55	P14,5s	1	93106967	5994100012115
		BL2				1	93108024	5994100020127
H4	50440MPU	B2	300	60/55	P43t	2	93106966	5994100012108
		B1				2	93110960	5994100029243
		BL2				2	93108029	5994100020226
H7	58520MPU	B2	500	55	PX26d	3	93106968	5994100012122
		B1				3	93110961	5994100029236
		BL2				3	93108025	5994100020349

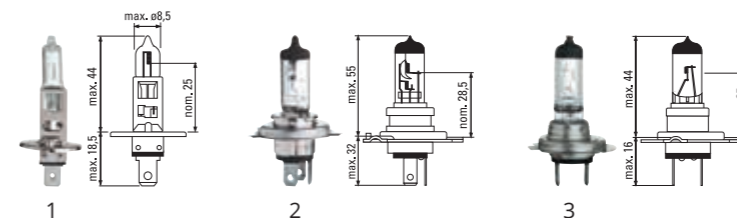

Always change the headlamps by pair.



### Jusqu'à 50-60% plus de lumière sur les routes

- Lampes phares qui fournissent plus de lumière quand et où vous en avez le plus besoin.



### Bis zu 50-60% mehr Licht auf der Straße

- Scheinwerferlampen, die mehr Licht bieten, wenn und wo Sie es am dringendsten benötigen.



### Ofrece hasta un 50-60% más de luz en carretera

- Lámparas para faros que ofrecen más luz cuando y donde más la necesitas.



### Fino al 50 - 60% di luce in più sulla strada

- Lampade per fari che forniscono più luce quando e dove ne avete più bisogno.

T<sub>c</sub> (HOUR) is the time up to which 63,2 % of tested lamps have ended their lives. Measured according to Tungsram life test specification. The life of the lamp is sensitive to the operation voltage of the car, 1% of change of the voltage results in 12-15% change of life with opposite sign.

# Sportlight Extreme



Blue-white light



More Light



Greater visibility

12V

PREMIUM

## Stylish blue-white light up to 5000K comparable with XENON

Visibly different - distinctive colour.

Up to 40% more light - greater illuminated area on the road ahead.

Combination of high luminance and colour that is closer to daylight.

STREET LEGAL

### Sportlight Extreme - Halogen headlight lamps

ECE	Type	Fig.	SKU	EAN	T <sub>c</sub>	W	Fig.	SKU	EAN	
H1	50310SUP	B2	1/9 set	93102855	250	55	P14,5s	1	93102855	5994100008316
		PB2	1/5 set	93093890				1	93093890	5994100006848
H4	50440SUP	B2	1/9 set	93103546	250	60/55	P43t	2	93103546	5994100007838
		PB2	1/5 set	93093787				2	93093787	5994100006862
H7	58520SUP	B2	1/9 set	93103547	250	55	PX26d	3	93103547	5994100007845
		PB2	1/5 set	93093788				3	93093788	5994100006879
H11	53110SUP	B2	1/9 set	93103548	250	55	PGJ19-2	4	93103548	5994100007852
		PB2	1/5 set	93093565				4	93093565	5994100006855

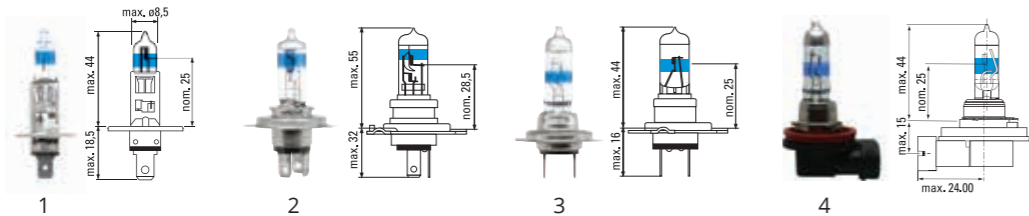

Always change the headlamps by pair.



### Lumière blanche et bleue élégante jusqu'à 5000K comparable au xénon

- Visibilité différente - couleur distinctive.
- Jusqu'à 40% plus de lumière - plus grande surface éclairée sur la route.
- Combinaison d' haute luminance et de couleur plus proche de la lumière du jour.



### Elegante luz azul-blanca de hasta 5000 Kelvin comparable con la lámpara XENÓN

- Visiblemente diferente - de color distintivo.
- Ofrece hasta un 40% más de iluminación - Mayor área iluminada en la visión frontal de la carretera.
- Combinación de alta luminosidad y de color más parecido a la luz natural.



### Stilvolles, blauweißes Licht bis zu 5000K, mit XENON vergleichbar

- Sichtbar anders - unverwechselbare Farbe.
- Bis zu 40% mehr Licht - Größere beleuchtete Fläche auf der Straße.
- Kombination von hoher Leuchtdichte und tageslichtähnlicher Farbe.



### Elegante luce blu-bianca fino a 5000 K paragonabile a quella allo Xenon

- Visibilmente differente - colore distintivo.
- Fino al 40% di luce in più - Maggiore area illuminata sulla strada da percorrere.
- Combinazione tra alta luminosità e colore si avvicina di più alla luce del giorno.

T<sub>c</sub> (HOUR) is the time up to which 63,2 % of tested lamps have ended their lives. Measured according to Tungsram life test specification. The life of the lamp is sensitive to the operation voltage of the car, 1% of change of the voltage results in 12-15% change of life with opposite sign.

# Sportlight Ultra



Blue-white light



More Light



Greater visibility

12V

PREMIUM

## Intense white light up to 4200K comparable with xenon

Visibly different - distinctive colour.

Produces a crisp, bright light that is closer to daylight.

Up to 30% more light on the road.

STREET LEGAL

### Sportlight Ultra - Halogen headlight lamps

ECE	Type	Fig.	SKU	EAN	T <sub>c</sub>	W	Fig.	SKU	EAN	
H1	50310SBU	B2	1/9 set	93097898	250	55	P14,5s	1	93097898	5994100007142
		PB2	1/5 set	93116884				1	93116884	5994100053507
		BL2	1/10 set	93108035				1	93108035	5994100020141
H4	50440SBU	B2	1/9 set	93098624	250	60/55	P43t	2	93098624	5994100007227
		PB2	1/5 set	93116885				2	93116885	5994100053446
		BL2	1/10 set	93108036				2	93108036	5994100020233
H7	58520SBU	B2	1/9 set	93097899	250	55	PX26d	3	93097899	5994100007159
		PB2	1/5 set	93116886				3	93116886	5994100053460
		BL2	1/10 set	93108037				3	93108037	5994100020356
H11	53110SBU	B2	1/9 set	93115206	250	55	PGJ19-2	4	93115206	5994100037095
		PB2	1/5 set	93116887				4	93116887	5994100053385
		BL2	1/10 set	93108037				3	93108037	5994100020356
HB3	9005SBU	B2	1/9 set	93115208	200	60	P20d	5	93115208	5994100037217
		PB2	1/5 set	93116889				5	93116889	5994100053408
HB4	9006SBU	B2	1/9 set	93115207	250	51	P22d	6	93115207	5994100037101
		PB2	1/5 set	93116888				6	93116888	5994100053392

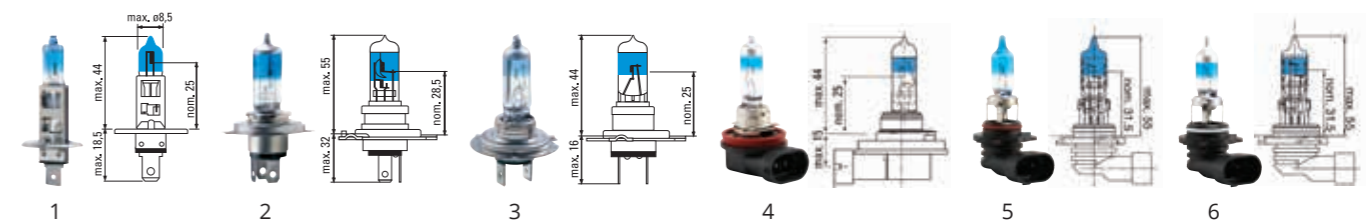

Always change the headlamps by pair.



### Lumière blanche intense comparable au xénon

- Visibilité différente - couleur distinctive.
- Produit une lumière vive et qui est plus proche de la lumière du jour.
- Jusqu'à 30% plus de lumière sur la route.



### Luz blanca intensa comparable con la lámpara de xenón

- Visiblemente diferente - de color distintivo.
- Produce una luz nítida y brillante más parecido a la luz natural.
- Ofrece hasta un 30% más de iluminación en la carretera.



### Intensives weißes Licht bis zu 4200K vergleichbar mit Xenon

- Sichtbar anders - unverwechselbare Farbe.
- Gibt ein klares, helles Licht, das tageslichtnäher ist.
- Bis zu 30% mehr Licht auf der Straße.



### Luce bianca intensa paragonabile allo Xenon

- Visibilmente differente - colore distintivo.
- Produce una luce nitida e brillante che si avvicina di più alla luce del giorno.
- Fino al 30% di luce in più sulla strada.

T<sub>c</sub> (HOUR) is the time up to which 63,2 % of tested lamps have ended their lives. Measured according to Tungsram life test specification. The life of the lamp is sensitive to the operation voltage of the car, 1% of change of the voltage results in 12-15% change of life with opposite sign.



# Sportlight



Blue-white light

More Light

Greater visibility

## Stylish white light up to 3800K

Up to 50% more light on the road.

Faster signal, earlier notice - miniature lamps.

STREET LEGAL



### Lumière blanche élégante jusqu'à 3800K

- Jusqu'à 50% plus de lumière sur la route.
- Signal plus rapide, préavis, lampes miniatures.



### Stilvolles, weißes Licht bis zu 3800K

- Bis zu 50% mehr Licht auf der Straße.
- Schnelleres Signal, früheres Merken - Miniaturlampen.



### Elegante luz blanca de hasta 3800 Kelvin.

- Ofrece hasta un 50% más de iluminación en la carretera.
- Señalización más rápida, anticipando aviso - lámparas miniatura.



### Elegante luce bianca fino a 3800K

- Fino al 50% di luce in più sulla strada.
- Segnale più veloce, avviso più rapido - lampade in miniatura.



## 12V

### Sportlight - Halogen headlight lamps

ECE	Type	Fig.	T <sub>c</sub>	W	Fig.	SKU	EAN	
H1	50310NHSU	B2 1/9 set	130	55	P14,5s	1	93106973	5994100012177
	BL2 1/10 set	1				93108026	5994100020134	
H4	50440SPU	B2 1/9 set	480	60/55	P43t	2	93106971	5994100012153
		BL2 1/10 set				2	93108032	5994100020257
H7	58520SPU	B2 1/9 set	250	55	PX26d	3	93106972	5994100012160
		BL2 1/10 set				3	93108031	5994100020370
HB3	9005NHSU	B2 1/9 set	235	60	P20d	4	93111380	5994100029281
HB4	9006NHSU	B2 1/9 set	760	51	P22d	5	93111379	5994100029298

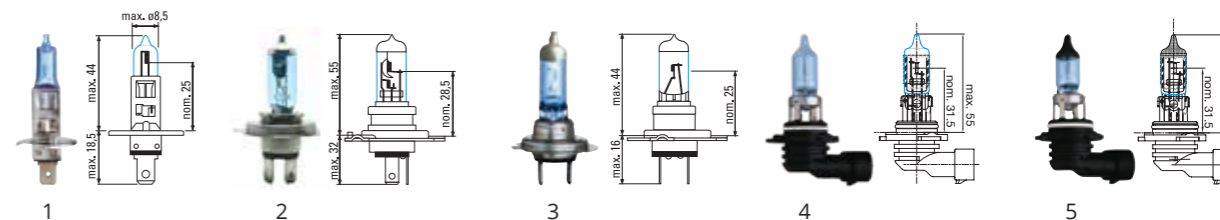

Always change the headlamps by pair.

### Sportlight - Miniature lamps

ECE	Type	Fig.	T <sub>c</sub>	W	Fig.	SKU	EAN	
P21W	1057NH	B1 1/10/200	320	21	BA15s	6	93106962	5994100012320
		B10 10/200				6	93106960	5994100012313
P21/5W	1077NH	B1 1/10/200	160/1600	21/5	BAY15d	7	93106961	5994100012344
		B10 10/200				7	93106959	5994100012337
R5W	2619NH	B1 1/10/200	300	5	BA15s	8	93111375	5994100029113
		B10 10/200				8	93111374	5994100029120
R10W	2641NH	B1 1/10/200	300	10	BA15s	8	93108009	5994100020035
		B10 10/200				8	93111373	5994100029137
W5W	501NH	B10 10/200	500	5	W2,1x9,5d	9	93108015	5994100020103

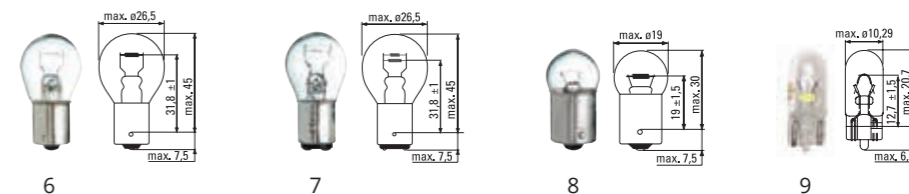

T<sub>c</sub> (HOUR) is the time up to which 63,2 % of tested lamps have ended their lives. Measured according to Tungstam life test specification. The life of the lamp is sensitive to the operation voltage of the car, 1% of change of the voltage results in 12-15% change of life with opposite sign.



Long life

## Longer driving periods

Extended lifetime, less need for replacement.

Ensures safe driving during day and night.

Up to 3x lifetime compared to standard lamps.

STREET LEGAL



### Périodes de conduite plus longues

- Durée de vie prolongée, moins besoin de remplacement.
- Assure une conduite sécurisante jour et nuit.
- Jusqu'à 3x de durée de vie par rapport au lampes standards.



### Längere Lenkzeiten

- Verlängerte Lebensdauer, weniger Ersatzbedarf.
- Sorgt für sicheres Fahren bei Tag und Nacht.
- Bis zu dreimal längere Lebensdauer im Vergleich zu Serienleuchten.



### Períodos de conducción más largos

- Con una vida útil prolongada, con necesidad de reemplazo menos frecuente.
- Garantiza una conducción segura durante el día y la noche.
- Dura hasta tres veces más en comparación con las lámparas estándares.



### Periodi di guida più lunghi

- Durata di vita estesa, meno necessità di sostituzione.
- Garantisce una guida sicura durante il giorno e la notte.
- Durata di vita fino a 3 volte superiore rispetto alle lampade standard.



# 12V

## Long Life - Halogen headlight lamps

ECE	Type	Fig.	T <sub>c</sub>	W	Fig.	SKU	EAN		
H1	50310LU	B2	2000	55	P14,5s	1	93097344	5994100007098	
		B1				1/10/100	1	93111384	5994100029045
		BL2				1/10 set	1	93105779	5994100010029
H3	50340LU	B2	2500	55	PK22s	2	93098491	5994100007104	
H4	50440LU	B2	3500	60/55	P43t	3	93097896	5994100007111	
		B1				1/10/100	3	93113949	5994100031987
		BL2				1/10 set	3	93108022	5994100020219
H7	58520LU	B2	1250	55	PX26d	4	93097897	5994100007128	
		B1				1/10/100	4	93108021	5994100020325
		BL2				1/10 set	4	93108023	5994100020318

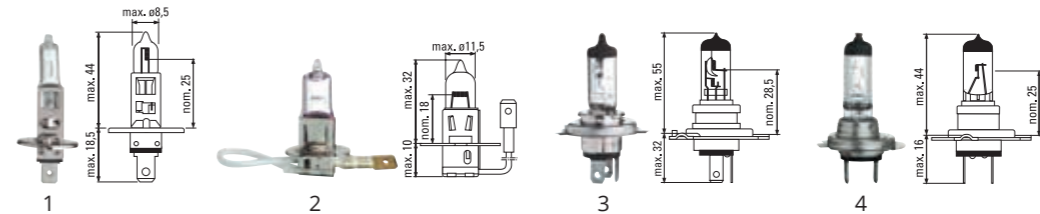

Always change the headlamps by pair.

## Long Life - Miniature lamps

ECE	Type	Fig.	T <sub>c</sub>	W	Fig.	SKU	EAN	
P21W	1057L	B1	1000	21	BA15s	5	93088711	5994100005537
		BL2				1/10 set	5	93088264
PY21W	1056L	B1	3000	21	BAU15s	6	93090295	5994100005438
P21/5W	1077L	B1	1000/5000	21/5	BAY15d	7	93088859	5994100005643
		BL2				1/10 set	7	93088860
P21/4W	1122L	B1	1000/5000	21/4	BAZ15d	7	93108020	5994100012900
R5W	2619L	B1	1500	5	BA15s	8	93106963	5994100012375
		BL2				1/10 set	8	93105780
R10W	2641L	B1	1600	10	BA15s	8	93108017	5994100020028
C5W	7546L	B1	4000	5	SV8,5	9	93108018	5994100020431
		BL2				1/10 set	9	93111369
W5W	930	B10	2000	5	W2,1x9,5d	10	93108012	5994100020455
		B1				1/10/200	10	93108016
T4W	2662L	B1	1500	4	BA9s	11	93108019	5994100020080
		BL2				1/10 set	11	93111368
H6W	52830LU	B1	1000	6	BAX9s	12	93111377	5994100029090
WY16W	WY16WNAL	B10	2000	16	W2,1x9,5d	13	93111387	5994100029038
		BL2				1/10 set	13	93111386

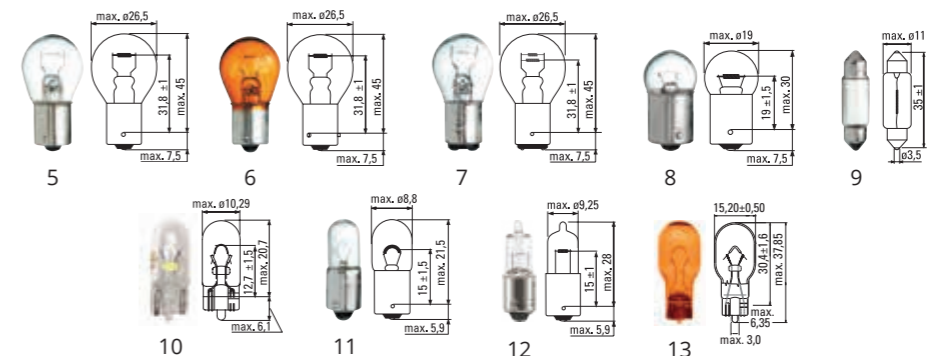

T<sub>c</sub> (HOUR) is the time up to which 63,2 % of tested lamps have ended their lives. Measured according to Tungsham life test specification. The life of the lamp is sensitive to the operation voltage of the car, 1% of change of the voltage results in 12-15% change of life with opposite sign.



OFF ROAD

High wattage headlight and foglight lamps for **OFF ROAD** use only



## 12V

### Rally - Halogen headlight lamps - Rally types are not allowed on public roads

Type	Fig.	W	Fig.	SKU	EAN		
52140U (H1*)	B1	1/10/100	100	P14,5s	1	93105079	5994100009610
	BL1	1/10			1	93105781	5994100010104
50370U (H1*)	B1	1/10/100	100	P14,5s/R	1	93106964	5994100012085
50360U (H3*)	B1	1/10/100	100	PK22S/R	2	93106965	5994100012092
52130U (H3*)	B1	1/10/200	100	Pk22s	2	93105085	5994100009672
	BL1	1/10			2	93105787	5994100010098
52030U (H4*)	B1	1/10/100	100/80	P45t	3	93105083	5994100009658
52100U (H4*)	B1	1/10/100	100/80	P43t	4	93103596	5994100008453
52100U (H4*)	B1	1/10/100	100/90	P43t	4	93111367	5994100029175
52670U (H4*)	B1	1/10/100	140/100 250/140CP	P43t	4	93103597	5994100008460
59000U (H7*)	B1	1/10/100	100	PX26d	5	93098354	5994100007166

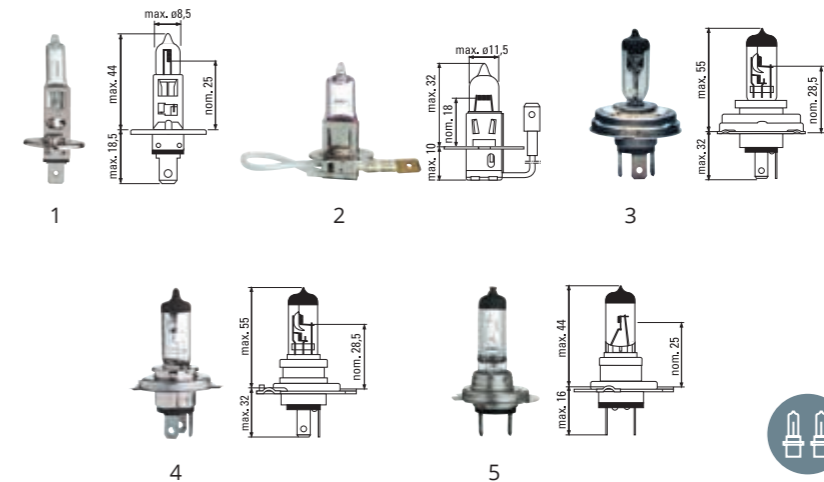

Lampes phares et anti-brouillard à haute puissance pour l'utilisation 'OFF- ROAD'



Hochwattscheinwerfer- und Nebelscheinwerferlampen die speziell für „OFF ROAD“ oder als „RALLYLAMPEN“ genutzt werden können.



Faros delanteros y luces antiniebla de alta potencia para uso exclusivo EN VÍAS NO OFICIALES



Fari anteriori e fari fendinebbia ad alta potenza esclusivamente per uso OFF ROAD

\* Lamp type shown for information only. These lamps are not ECE approved.

# 12V Tungfram 'Original' range

## Halogen headlight lamps

ECE	Type	Fig.	W	Fig.	SKU	EAN		
H1	50310U	B1	1/10/100	55	P14,5s	1	93103272	5994100008415
		BL1	1/10			1	93105767	5994100010012
H3	50340U	B1	1/10/200	55	Pk22s	2	93103598	5994100008477
		BL1	1/10			2	93105766	5994100010043
H4	50440U	B1	1/10/100	60/55	P43t	3	93103274	5994100008439
		BL1	1/10			3	93105768	5994100010074
	52040U	B1	1/10/100	60/55 130/80CP	P45t	7	93106975	5994100012191
	52050U	B1	1/10/100	60/55 130/80CP	P43t	3	93105102	5994100009740
	52070U	B1	1/10/100	60/55	P45t	7	93105101	5994100009733
H7	58520SU	B1	1/10/100	35/35	P43t	3	93111382	5994100029069
		BL1	1/10			4	93105769	5994100010159
	58520U*	B1	1/10/100	55	PX26d	4	93107999	5994100008446
H8	28076	B1	1/10/100	35	PGJ19-1	5	93104191	5994100009313
		BL1	1/10			5	93105775	5994100010128
H9	28077	B1	1/10/100	65	PGJ19-5	6	93104192	5994100009320
		BL1	1/10			6	93105776	5994100010135
H11	28078	B1	1/10/100	55	PGJ19-2	5	93104193	5994100009337
		BL1	1/10			5	93105794	5994100010142
H16	54790U	B1	1/10/100	19	PGJ19-3	9	93117211	5994100057338
HS1	50470U	B1	1/10/100	35/35	PX43t	3	93105082	5994100009641
R2	52950U	B1	1/10/100	45/40	P45t	7	93107998	5994100020295
		M5 MOTO	B1	1/10/100	35/35	P15D-25-1	8	93113962

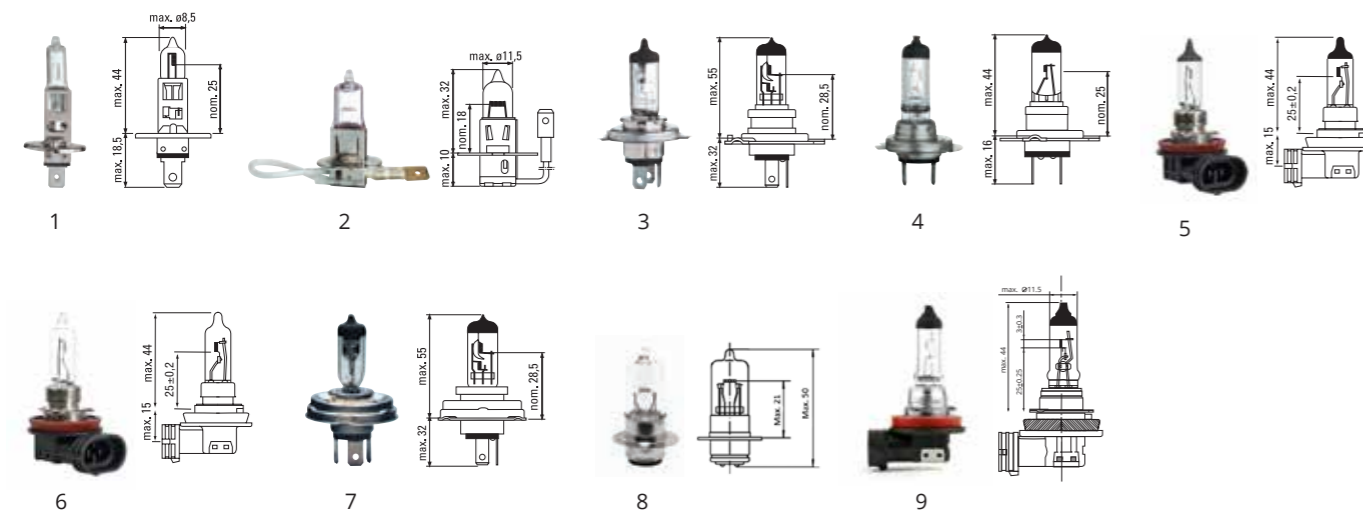

58520U\* - increased life

# 12V Tungfram 'Original' range

## Halogen headlight lamps

ECE	Type	Fig.	W	Fig.	SKU	EAN		
HB3	28005M	B1	1/10/100	60	P20d	1	93105080	5994100009627
		BL1	1/10			1	93105777	5994100010210
HB4	28006	B1	1/10/100	51	P22d	2	93105081	5994100009634
		BL1	1/10			2	93105778	5994100010227
H10	28095	B1	1/10/100	42	PY20d	3	93110962	5994100029229
HIR 2	54430U	B1	1/10/100	55	PX22d	4	93111389	5994100029021
H27W/1	54480U	B1	1/10/100	27	PG13	5	93106980	5994100012221
H27W/2	54490U	B1	1/10/100	27	PGJ13	6	93106981	5994100012238

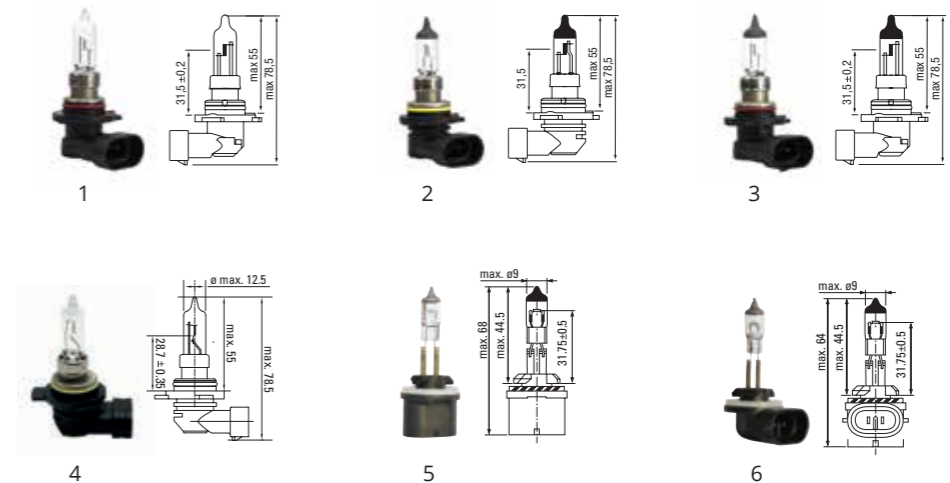



# Miniature lamps

- side signals, warning lamps
- stop lamps
- rear fog lamps
- license plate
- reverse lamps
- parking lamps
- dashboard lamps
- interior lamps
- indicator lamps
- side turn signal lamps



# 12V Tungfram 'Original' range

## Miniature lamps

ECE	Type	Fig.	W	Fig.	SKU	EAN
CSW	7546	B1	1/10/200	5	SV8,5-8	1 93108002 5994100020424
		B10	10/200			1 93103622 5994100008712
		BL2	1/10 set			1 93105770 5994100010173
	7581	B10	10/200	10	SV8,5-8	1 93110521 5994100027874
	7575	B10	10/200	5	SV8,5-8	2 93104310 5994100009504
		BL2	1/10 set			2 93105786 5994100010180
DIN 72601K	7576	B1	1/10/200	10	SV8,5-8	2 93108003 5994100020448
		B10	10/200			2 93103619 5994100008682
		BL2	1/10 set			2 93105784 5994100010197
	91735	B1	1/10/200	10	SV8,5-8	3 93110525 5994100027843
		B10	10/200			3 93110519 5994100027898
		BL2	1/10 set			3 93110517 5994100027966
	7592	B10	10/200	15	SV8,5-8	4 93104312 5994100009528
		BL2	1/10 set			4 93105792 5994100010203
	7593	B10	10/200	18	SV8,5-8	4 93104313 5994100009535
	7564	B10	10/200	3	SV7-8	5 93110520 5994100027881
	58560	B1	1/20	10	BA9s	6 93111370 5994100029168
H6W	52830U	B1	1/10/100	6	BAX9s	7 93105097 5994100009696
		BL1	1/10			7 93111372 5994100029144
H21W	53990U	B10	1/10/200	21	BAY9S	8 93110533 5994100026372
HY21W	54410U	B10	10/200	21	BAY9S	9 93117206 5994100056782

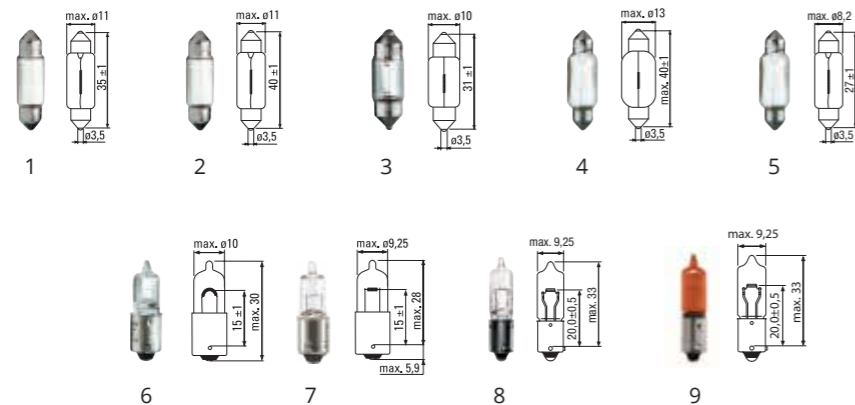

# 12V Tungfram 'Original' range

## Miniature lamps

ECE	Type	Fig.	W	Fig.	SKU	EAN
P21W	1057	B1	1/10/200	21	BA15s	1 93088857 5994100005452
		B10	10/200			1 93103601 5994100008507
		BL2	1/10 set			1 93088856 5994100005445
P21W	1058	B10	10/200	21	BA15d	2 93103600 5994100008491
DIN72601R	1059	B10	10/200	18	BA15s	3 93104195 5994100009351
DIN72601F	1143	B10	10/200	15	BA15s	3 93104301 5994100009412
PY21W	1056	B1	1/10/200	21	BAU15s	4 93088712 5994100005421
		B10	10/200			4 93103603 5994100008521
		BL2	1/10 set			4 93088263 5994100005414
P21/5W	1077	B1	1/10/200	21/5	BAY15d	5 93088858 5994100005629
		B10	10/200			5 93103607 5994100008569
		BL2	1/10 set			5 93089848 5994100005612
	1098	B10	10/200	20/5	BA15d	5 93104303 5994100009436
		BL2	1/10 set			5 93105791 5994100009924
P21/4W	1122	B10	10/200	21/4	BAZ15d	5 93103606 5994100008552
		BL2	1/10 set			5 93105785 5994100009931

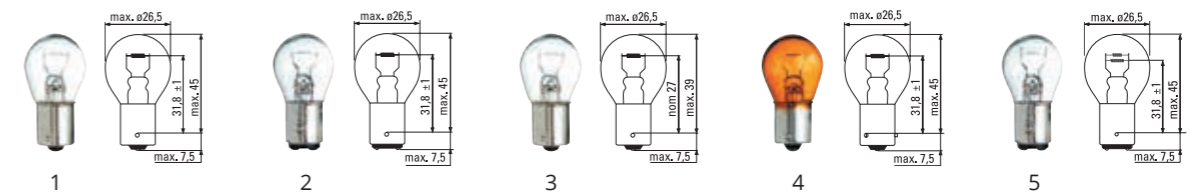



# 12V Tungstram 'Original' range

## Miniature lamps

ECE	Type	Fig.	W	Fig.	SKU	EAN
R5W	2619	B1	1/10/200	5	BA15s	1 93106956 5994100012368
		B10	10/200			1 93103608 5994100008576
		BL2	1/10 set			1 93105772 5994100009955
R5W	2619T	B10	10/200	5	BA15s	2 93103612 5994100008613
R10W	2641	B1	1/10/200	10	BA15s	1 93108000 5994100020011
		B10	10/200			1 93103609 5994100008583
		BL2	1/10 set			1 93105771 5994100009979
R10W	2641T	B10	10/200	10	BA15s	2 93103613 5994100008620
RY10W	2641A	B10	10/200	10	BAU15s	3 93120181 5994100086826
DIN 72601J	2696	B10	10/200	2	BA7s	4 93104308 5994100009481
		B10	10/200	3	BA9s	5 93103614 5994100008637
		B10	10/200	2	BA9s	5 93103615 5994100008644
T4W	2662	B1	1/10/200	4	BA9s	6 93108001 5994100020073
		B10	10/200			6 93103618 5994100008675
		BL2	1/10 set			6 93105773 5994100009986
	5301	B1	1/10/200	1,2	W2x4,6d	7 93108008 5994100020301
		B10	10/200			7 93103626 5994100008750
		BL2	1/10 set			7 93105782 5994100010111
	5313	B10	10/200	2	W2,1x9,5D	8 93104316 5994100009566
	5330PS	B10	10/200	1,2	B8,5d	9 93110435 5994100027928
		B1	1/10/200			9 93110526 5994100027836
	5332PS	B10	10/200	2	BX8,4d	10 93110531 5994100026396
	5333PS	B10	10/200	1,2	BX8,4d	11 93110532 5994100026389
	91605	B10	10/200	2	W2x4,6d	7 93110536 5994100026341

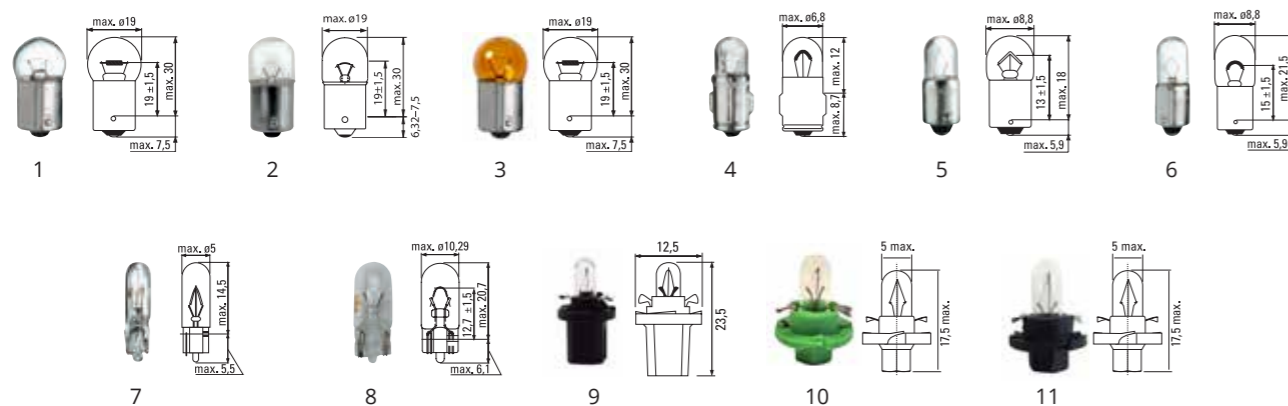

# 12V Tungstram 'Original' range

## Miniature lamps

ECE	Type	Fig.	W	Fig.	SKU	EAN
W3W	504	B1	1/10/200	3	W2,1x9,5d	1 93108006 5994100020202
		B10	10/200			1 93103625 5994100008743
		BL2	1/10 set			1 93105783 5994100010067
W5W	501	B1	1/10/200	5	W2,1x9,5d	2 93108007 5994100020097
		B10	10/200			2 93103623 5994100008729
		BL2	1/10 set			2 93105774 5994100009993
W5W	501NB	B10	10/200	5	W2,1x9,5d	3 93111381 5994100029076
		BL2	1/10 set			3 93111385 5994100029274
WY5W	501NA	B10	10/200	5	W2,1x9,5d	4 93103624 5994100008736
		BL2	1/10 set			4 93105795 5994100010005
W16W	W16W	B10	10/200	16	W2,1x9,5d	5 93106983 5994100012252
WY16W	WY16WNAL	B10	10/200	16	w2,1x9,5d	6 93111387 5994100029038
		BL2	1/10 set			6 93111386 5994100029267
W21W	7440	B1	1/10/100	21	W3x16d	7 93110530 5994100026402
		BL2	1/10 set			7 93110528 5994100027942
WY21W	7440NA	B1	1/10/100	21	W3x16d	8 93110523 5994100027850
		BL2	1/10 set			8 93110524 5994100027959
W21/5W	7443	B1	1/10/100	21/5	W3x16q	9 93110529 5994100027812
		BL2	1/10 set			9 93110537 5994100027935
	7443NA	B1	1/10/200	21/5	W3x16q	10 93110538 5994100026334

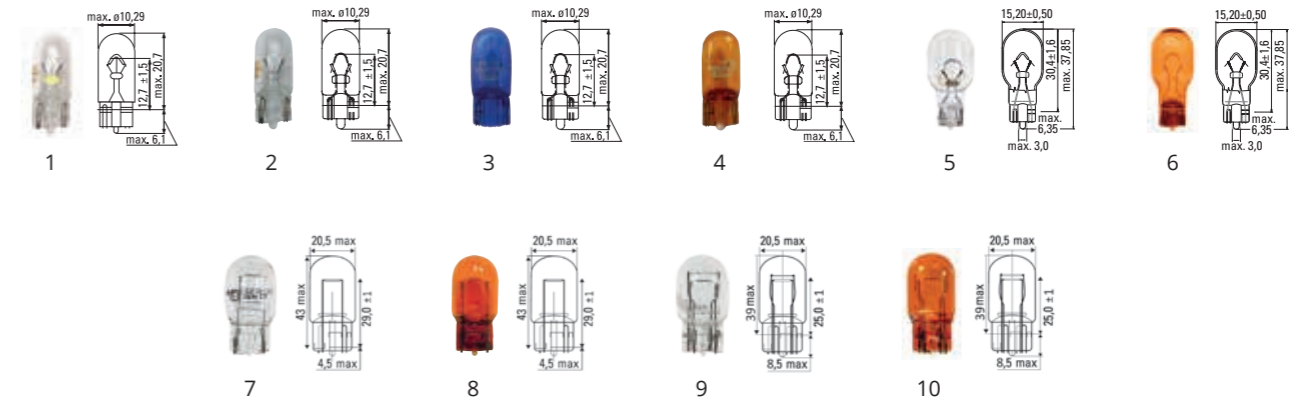

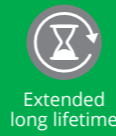

Extended long lifetime



More robust

STREET LEGAL

## 24V Truck lamps with longer life and increased robustness

Designed and manufactured to withstand the demands of the professional commercial vehicle market. Tungfram 24V bulbs are the first choice for both the fleet and specialist users.

Longer intervals between changes, more economical driving.



## 24V

### Heavy Star - Halogen headlight lamps

ECE	Type	Fig.	W	Fig.	SKU	EAN		
H1	50320U_HDL	B1	1/10/100	70	P14,5s	1	93105106	5994100009788
H3	50350U_HDL	B1	1/10/100	70	Pk22s	2	93105105	5994100009771
H4	50450HDLU	B1	1/10/100	75/70	P43t	3	93105107	5994100009795
H7	58521LU_HDL	B1	1/10/100	70	Px26d	4	93105108	5994100009801

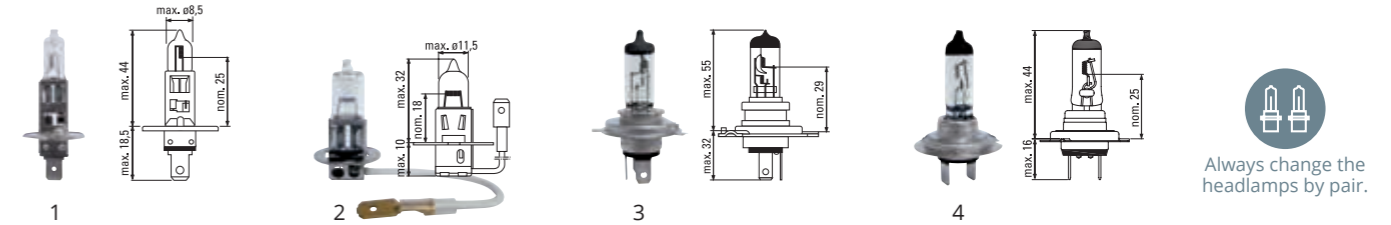

### Heavy Star - Miniature lamps

ECE	Type	Fig.	W	Fig.	SKU	EAN		
P21W	1060HDL	B10	10/200	21	BA15s	5	93097345	5994100007173
P21W	1061HDL	B10	10/200	21	BA15d	6	93111378	5994100029083
PY21W	1073HDNA_L	B10	10/200	21	BAU15s	7	93097343	5994100007135
R5W	2627HDL	B10	10/200	5	BA15s	8	93095324	5994100006923
R10W	2643HDL	B10	10/200	10	BA15s	8	93095977	5994100007319
T4W	2661HDL	B10	10/200	4	BA9S	9	93108010	5994100020066

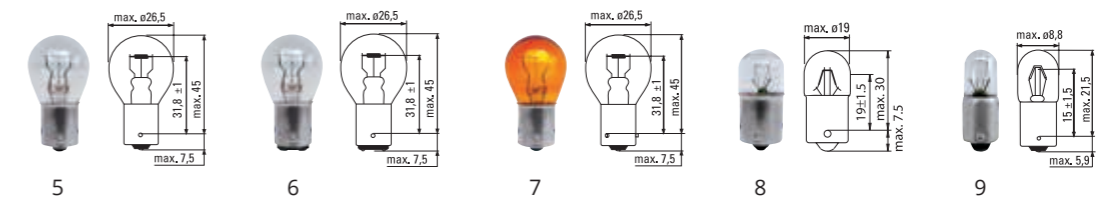

### Lampes 24V de camion avec une durée de vie plus longue et une robustesse accrue

- Conçue et fabriquée pour résister aux exigences du marché des véhicules utilitaires professionnels.
- intervalles plus longs entre les changements.



### 24V Truck-Lampen mit längerer Lebensdauer und erhöhter Robustheit

- Entwickelt und hergestellt, um den Anforderungen des professionellen Nutzfahrzeugmarktes standzuhalten. Tungfram 24V-Lampen sind die erste Wahl für sowohl Flotten- als auch spezialisierte Anwender.
- Längere Wechselintervalle und wirtschaftlicheres Fahren.



### Lámparas de camión de 24v, con una duración de vida más larga y una mayor solidez

- Diseñado y fabricado para satisfacer la demanda del mercado profesional de vehículos comerciales. Las lámparas Tungfram de 24v son la primera opción para flotas de vehículos así como usuarios especializados.
- Intervalos más largos para reemplazar la lámpara y con una conducción más económica.



### Lampade per veicoli industriali a 24V con maggiore durata e maggiore robustezza

- Progettate e realizzate per resistere alle esigenze del mercato dei veicoli commerciali professionali. Le lampadine Tungfram 24V sono la prima scelta sia per la flotta di veicoli che per gli utenti specialisti.
- Intervalli di sostituzione più lunghi, guida più economica.









# Accessories

## LED Inspection lamps

LED Inspection lamps are high-quality lamps suitable for Automotive garages and many other industries, providing exceptional brightness.

Hands-free lamps which incorporate hooks and magnets to secure them. They are equipped with a long-lasting and rechargeable battery and can be charged via USB.

Type 63000 can be charged using the AC/DC adapter included in the package. It can be also connected to the docking station included in the package.

Type 63020 with its flexible design offers even more comfort and efficiency while working inside hard to reach areas



Type	CCT (K)	LUMENS	Fig.	SKU	EAN
63000	6000	1000/500	1/12 pcs	93114126	5994100032113
63010	5700	240/140	1/12 pcs	93114055	5994100032120
63020	5700	500//250/100	1/10 pcs	93118049	5994100069713

**Storage and Operation temperature:**  
-10 °C to +40 °C

## Displays

In order to satisfy our customers' needs and facilitate the sales of Tungram products, we provide customers with a range of solutions to show and store auto bulbs at the point of sale or installation.

Containing the fast moving references in a choice of either single, 10 way or twin boxes, or blister packs, these wall mounted or counter displays offer easy access to Tungram 12V, 24 V standard and premium ranges, are practical for everyday use - with an easy removal and refill of lamps.



### Car shaped display – shipped without lamps Vacuum molded plastic (PS), metal hooks

- High quality materials, attractive car shaped design with blinking LED lights
- No defined lamp positions - row of hooks suitable for presenting blister packs, single boxes, premium twin boxes, new products
- Drawer for free placement of any additional lamp type
- Size: 55,5x76x41 cm

**SKU: 93115085**

## UV Air Purifier Cube E9008



Tungram is a developer of efficient, easy-to-use and affordable UV light purifier solution and is proud to introduce it as part of the UV Sanitizer Series. This brand-new product is an essential purifier system, working with the following method:

Purifying effect is based on the photocatalytic degradation of chemical pollutants and microbes, such as formaldehyde, hydrocarbons, bacteria, fungi and viruses.

Nano TiO<sub>2</sub> coating of nickel mesh acts as a highly active catalyst under UV-A irradiation. It oxidizes and decomposes organic substances into harmless products such as CO<sub>2</sub> and water to achieve the purpose of deodorization and disinfection/sanitization.



EAN	5994100087205
Packaging	1/12/48
Wattage	1.5 W
Voltage	5 V
LED Quantity	4 + 2 pcs
Power Source	USB-B to USB-A wire

- Compact design, easy to use
- Aluminum Alloy Housing Material, Black PC, Anti-UV Cover
- Magnet fixing
- Ozone free

**SKU: 93120321**

## Wall cupboard – shipped without lamps

### Vacuum molded plastic (PS) with lock

- High quality materials, attractive design, practical for everyday use - easy removal and refill of lamps
- Defined lamp positions - discharge, basic halogen, miniature lamps
- 2 drawers for free placement of any additional lamp type
- Size: 61 x 14 x 71 cm

#### SUGGESTED CONTENT:

H4, H7, H1 – 20-20 pcs single boxes  
D1S, D1R – 3-3 pcs single boxes  
D2S – 4 pcs single boxes  
P21W, P21/5W, PY21W – 1-1 pc ten way box  
R5W – 2 pcs ten way boxes  
R10W – 1 pc ten way box  
T4W – 2 pcs ten way boxes  
W1, 2W, W3W, W5W – 1-1 pc ten way box  
C5W, H6W or any other lamp types in bulk or box pack in the 2 drawers

**SKU: 93115081**



## Generic counter/desk or wall display shipped without lamps

### Vacuum molded plastic (PS), metal hooks

- High quality materials, attractive design, showing main premium ranges features, benefits
- Graphic interface with 6 small LED blinking lights
- No defined lamp positions – suggested for use of premium halogen lamps, 18 twinboxes or blisters (any mix)
- Installation: desk stand or wall mounted
- Size: 37x57x22cm

SKU: 93115086



## Carton blister display shipped without lamps

- High quality 5 layer carton, attractive design
- 20 plastic hooks - 5 hooks in 1 row for blisters, plastic boxes or twin boxes or 3 hooks in 1 row for H4 blisters + 2 shelves – suitable for any kinds of lamps
- Size: 602x401x 1599 mm
- POS material for temporary promotional use!

SKU: 93120525 EAN: 5994100090878



## Carton display shipped without lamps

- High quality carton, attractive design
- Suitable for premium halogen lamps, 9 twin boxes (any mix)
- Size: 30,5x17x 23,5cm

SKU: 93115087



## Car shaped wall display shipped with or without lamps

### Vacuum formed plastic

- With positions for halogen boxes
- Foam insert suitable for miniature lamps
- Place for 161 lamps all together
- Size: 77cm x 55cm

#### CONTENT:

H1 – 6 pcs      P21/5W – 30 pcs  
 H4 – 5 pcs      R5W – 20 pcs  
 H7 – 10 pcs     C5W – 20 pcs  
 P21W – 20 pcs   W5W – 20 pcs  
 PY21W – 10 pcs   W1,2W – 20 pcs

SKU: 93115641 (empty)

SKU: 93115643 (filled)



## Halogen premium ranges

Carton twin box and Plastic twin box packaging selection

		H1	H4	H7	H11	HB3	HB4
Megalight Ultra +200	plastic box		●	●			
	carton box		●	●			
Megalight Ultra +150	plastic box	●	●	●	●		
	carton box	●	●	●	●		
Megalight Ultra +130	plastic box	●	●	●	●		
	carton box	●	●	●	●		
Megalight Ultra +120	plastic box	●	●	●	●	●	●
	carton box	●	●	●	●	●	●
Megalight Ultra +90	plastic box	●	●	●	●	●	●
	carton box	●	●	●	●	●	●
Megalight Plus	plastic box			●			
	carton box			●			
Sportlight Extreme	plastic box	●	●	●	●		
	carton box	●	●	●	●		
Sportlight Ultra	plastic box	●	●	●	●	●	●
	carton box	●	●	●	●	●	●
Sportlight	plastic box						
	carton box	●	●	●		●	●



# Tungfram PREMIUM packaging variations

Colour coded premium packages tied directly to POS messaging for easy identification:

- differentiation across various premium ranges
- with feature/benefit logo, explain how one product differs from another, and why it is most appropriate for its task
- rationalize the move to upsell in the halogen and miniature lamp categories

## SINGLE BOX

<b>Packaging type</b>	B1 single box
<b>Content</b>	1 lamp
<b>Material</b>	carton



Premium benefit pictograms



Up to +20% more light

## CARTON TWIN BOX

<b>Packaging type</b>	B2 twin box set
<b>Content</b>	2 lamps
<b>Material</b>	carton/plastic



Premium benefit pictograms

## PLASTIC TWIN BOX

<b>Packaging type</b>	PB2 plastic twin box set
<b>Content</b>	2 lamps
<b>Material</b>	plastic



Premium benefit pictograms

- ✓ Emphasize premium features, benefits
- ✓ Coherent with standard, but more upsell look
- ✓ Easy identification, differentiations across various ranges

\*SET - unit of measure. It contains two bulbs in a twin box or blister. Orders should be accepted and entered into the system as 'set'.

# Tungfram BASIC packaging variations

As a major supplier to automotive OEM and aftermarket customers for decades, Tungfram continues to perform groundbreaking work in terms of meeting its customers' needs of not only today, but also striving to find solutions to their problems of the future too.

Our heritage is the outstanding quality represented in each manufactured product and the innovation that keeps driving the company toward new challenges. As such, our forward-thinking mentality has helped us to create a packaging design that improves the customer experience and aids the upselling process and increasing sales.

## SINGLE BOX

<b>Packaging type</b>	B1 single pack
<b>Content</b>	1 lamp
<b>Material</b>	carton



H7 (E1) 23P  
12V 55W  
PX26d  
58520U B1  
SW

Product description and main data

## 10 WAY BOX

<b>Packaging type</b>	B10 10 way pack
<b>Content</b>	10 lamps
<b>Material</b>	carton



Differentiate 24V with green colour

C5W 24V  
MINIATURE

## SINGLE BLISTER

<b>Packaging type</b>	BL1 single blister
<b>Content</b>	1 lamp
<b>Material</b>	carton/plastic



## TWIN BLISTER

<b>Packaging type</b>	BL2 twin blister set
<b>Content</b>	2 lamps
<b>Material</b>	carton/plastic

\*SET - unit of measure. It contains two bulbs in a twin box or blister. Orders should be accepted and entered into the system as 'set'.

# SKU/EAN reference

SKU	EAN	SKU	EAN	SKU	EAN	SKU	EAN	SKU	EAN	SKU	EAN	SKU	EAN	SKU	EAN
93088611	599410006817	93098619	5994100007067	93103621	5994100008705	93105096	5994100009689	93106970	5994100012146	93110527	5994100027829	93113955	5994100032045	93116884	5994100053507
93088612	5994100006831	93098620	5994100007050	93103621	5994100008705	93105096	5994100009689	93106970	5994100012146	93110527	5994100027829	93113956	5994100032052	93116885	5994100053446
93088711	5994100005537	93098621	5994100007043	93103627	5994100008767	93105098	5994100009702	93106971	5994100012153	93110534	5994100026365	93115172	5994100036166	93116886	5994100053460
93088859	5994100005643	93098622	5994100007036	93103627	5994100008767	93105098	5994100009702	93106972	5994100012160	93110534	5994100026365	93115173	5994100036173	93116887	5994100053385
93090295	5994100005438	93098623	5994100007029	93104194	5994100009344	93105099	5994100009719	93106973	5994100012177	93110535	5994100026358	93115174	5994100036180	93116888	5994100053392
93093565	5994100006855	93098624	5994100007227	93104194	5994100009344	93105099	5994100009719	93106974	5994100012184	93110535	5994100026358	93115175	5994100036197	93116889	5994100053408
93093630	5994100006886	93098625	5994100007012	93104296	5994100009368	93105100	5994100009726	93106974	5994100012184	93110959	5994100025047	93115206	5994100037095	93116890	5994100053552
93093633	5994100006893	93100448	5994100008118	93104296	5994100009368	93105100	5994100009726	93106976	5994100012290	93110959	5994100025047	93115207	5994100037101	93116891	5994100053569
93093787	5994100006862	93100449	5994100008125	93104297	5994100009375	93105103	5994100009757	93106977	5994100012306	93110960	5994100029243	93115208	5994100037217	93117208	5994100056805
93093788	5994100006879	93102855	5994100008316	93104297	5994100009375	93105103	5994100009757	93106978	5994100012207	93110961	5994100029236	93115659	5994100044253	93117209	5994100056812
93093890	5994100006848	93103273	5994100008422	93104298	5994100009382	93105104	5994100009764	93106979	5994100012214	93110963	5994100029212	93115660	5994100044260	93117210	5994100056829
93095324	5994100006923	93103273	5994100008422	93104298	5994100009382	93105104	5994100009764	93106982	5994100012245	93110963	5994100029212	93115661	5994100044277	93117214	5994100056850
93095510	5994100006985	93103546	5994100007838	93104299	5994100009399	93105105	5994100009771	93107996	5994100020059	93111367	5994100029175	93115662	5994100044284	93117215	5994100056867
93095511	5994100006978	93103547	5994100007845	93104299	5994100009399	93105106	5994100009788	93107996	5994100020059	93111371	5994100029151	93115663	5994100044291	93120535	5994100090977
93095512	5994100006930	93103548	5994100007852	93104300	5994100009405	93105107	5994100009795	93108004	5994100020042	93111371	5994100029151	93115664	5994100044307	93120536	5994100090984
93095513	5994100006947	93103596	5994100008453	93104300	5994100009405	93105108	5994100009801	93108004	5994100020042	93111373	5994100029137	93115665	5994100044512	93120598	5994100091004
93095514	5994100006961	93103597	5994100008460	93104304	5994100009443	93106564	5994100012283	93108009	5994100020035	93111374	5994100029120	93115676	5994100044529	93120599	5994100091318
93095970	5994100006954	93103599	5994100008484	93104304	5994100009443	93106565	5994100012382	93108010	5994100020066	93111375	5994100029113	93116866	5994100053484	93120749	5994100094401
93095977	5994100007319	93103599	5994100008484	93104305	5994100009450	93106565	5994100012382	93108012	5994100020455	93111377	5994100029090	93116867	5994100053439	93120750	5994100094616
93096783	5994100007418	93103602	5994100008514	93104305	5994100009450	93106957	5994100012399	93108015	5994100020103	93111378	5994100029083	93116868	5994100053521	93120751	5994100094371
93097343	5994100007135	93103602	5994100008514	93104306	5994100009467	93106957	5994100012399	93108016	5994100020462	93111379	5994100029298	93116869	5994100053347	93120752	5994100094388
93097344	5994100007098	93103604	5994100008538	93104306	5994100009467	93106958	5994100012351	93108017	5994100020028	93111380	5994100029281	93116870	5994100053354	93120753	5994100094395
93097345	5994100007173	93103604	5994100008538	93104307	5994100009474	93106958	5994100012351	93108018	5994100020431	93111384	5994100029045	93116871	5994100053361		
93097896	5994100007111	93103605	5994100008545	93104307	5994100009474	93106959	5994100012337	93108019	5994100020080	93111387	5994100029038	93116872	5994100053538		
93097897	5994100007128	93103605	5994100008545	93104311	5994100009511	93106960	5994100012313	93108020	5994100012900	93111388	5994100029250	93116873	5994100053453		
93097898	5994100007142	93103610	5994100008590	93104311	5994100009511	93106961	5994100012344	93108021	5994100020325	93113850	5994100031994	93116874	5994100053491		
93097899	5994100007159	93103610	5994100008590	93104314	5994100009542	93106962	5994100012320	93108044	5994100020417	93113894	5994100031932	93116875	5994100053378		
93098354	5994100007166	93103611	5994100008606	93104314	5994100009542	93106963	5994100012375	93108045	5994100020288	93113895	5994100031949	93116876	5994100053545		
93098491	5994100007104	93103611	5994100008606	93104315	5994100009559	93106964	5994100012085	93108046	5994100020165	93113946	5994100031956	93116877	5994100053415		
93098492	5994100007180	93103616	5994100008651	93104315	5994100009559	93106965	5994100012092	93110516	5994100027911	93113947	5994100031963	93116878	5994100053514		
93098493	5994100007197	93103616	5994100008651	93105079	5994100009610	93106966	5994100012108	93110516	5994100027911	93113949	5994100031987	93116879	5994100053422		
93098494	5994100007203	93103617	5994100008668	93105083	5994100009658	93106967	5994100012115	93110518	5994100027904	93113951	5994100032007	93116880	5994100053477		
93098495	5994100006220	93103617	5994100008668	93105084	5994100009665	93106968	5994100012122	93110518	5994100027904	93113952	5994100032014	93116881	5994100053316		
93098616	5994100007081	93103620	5994100008699	93105084	5994100009665	93106969	5994100012139	93110522	5994100027867	93113953	5994100032021	93116882	5994100053323		
93098617	5994100007074	93103620	5994100008699	93105085	5994100009672	93106969	5994100012139	93110522	5994100027867	93113954	5994100032038	93116883	5994100053330		



# Tungsrám Blister range

Product Code	Type	Designation	Simplified number	Pack unit	Lamp in blister	Wattage	Volt	EAN code
93105767	50310U	H1	04	BL1 1/10	1	55W	12V	5994100010012
93108024	50310MPU	H1 Megalight Plus 50	04MPU	BL2 1/10 set	2	55W	12V	5994100020127
93108030	50310XU	H1 Megalight Ultra - Plus 90	04XU	BL2 1/10 set	2	55W	12V	5994100020172
93105797	50310NU	H1 Megalight Ultra - Plus 120	04NU	BL2 1/10 set	2	55W	12V	5994100010036
93108040	50310XNU	H1 Megalight Ultra - Plus 130	04XNU	BL2 1/10 set	2	55W	12V	5994100020158
93105779	50310LU	H1 Long Life	04LU	BL2 1/10 set	2	55W	12V	5994100010029
93108026	50310NHSU	H1 Sportlight	04NHSU	BL2 1/10 set	2	55W	12V	5994100020134
93108035	50310SBU	H1 Sportlight Ultra	04SBU	BL2 1/10 set	2	55W	12V	5994100020141
93105781	52140U	H1 Rally - offroad	104	BL1 1/10	1	100W	12V	5994100010104
93108005	50320U	H1	74	BL1 1/10	1	70W	24V	5994100020196
93105766	50340U	H3	05	BL1 1/10	1	55W	12V	5994100010043
93105787	52130U	H3 Rally - offroad	105	BL1 1/10	1	100W	12V	5994100010098
93105789	50350U	H3	75	BL1 1/10	1	70W	24V	5994100010050
93105769	58520SU	H7	03	BL1 1/10	1	55W	12V	5994100010159
93108031	58520SPU	H7 Sportlight	03SPU	BL2 1/10 set	2	55W	12V	5994100020370
93108037	58520SBU	H7 Sportlight Ultra	03SBU	BL2 1/10 set	2	55W	12V	5994100020356
93108025	58520MPU	H7 Megalight Plus 50	03MPU	BL2 1/10 set	2	55W	12V	5994100020349
93108028	58520SXU	H7 Megalight Ultra - Plus 90	03SXU	BL2 1/10 set	2	55W	12V	5994100020387
93108034	58520SNU	H7 Megalight Ultra - Plus 120	03SNU	BL2 1/10 set	2	55W	12V	5994100020363
93108038	58520XNU	H7 Megalight Ultra - Plus 130	03XNU	BL2 1/10 set	2	55W	12V	5994100020400
93108023	58520LU	H7 Long Life	03LU	BL2 1/10 set	2	55W	12V	5994100020318
93105793	58521U	H7 24V	77	BL1 1/10	1	70W	24V	5994100010166
93105768	50440U	H4	01	BL1 1/10	1	60/55W	12V	5994100010074
93105796	50450U	H4	71	BL1 1/10	1	60/55W	24V	5994100010081
93108029	50440MPU	H4 Megalight Plus 60	01MPU	BL2 1/10 set	2	60/55W	12V	5994100020226
93108027	50440SXU	H4 Megalight Ultra - Plus 90	01SXU	BL2 1/10 set	2	60/55W	12V	5994100020264
93108033	50440SNU	H4 Megalight Ultra - Plus 120	01SNU	BL2 1/10 set	2	60/55W	12V	5994100020240
93108039	50440XNU	H4 Megalight Ultra - Plus 130	01XNU	BL2 1/10 set	2	60/55W	12V	5994100020271
93108022	50440LU	H4 Long Life	01LU	BL2 1/10 set	2	60/55W	12V	5994100020219
93108032	50440SPU	H4 Sportlight	01SPU	BL2 1/10 set	2	60/55W	12V	5994100020257
93108036	50440SBU	H4 Sportlight Ultra	01SBU	BL2 1/10 set	2	60/55W	12V	5994100020233
93105777	28005M	HB3	07	BL1 1/10	1	60W	12V	5994100010210
93105778	28006	HB4	09	BL1 1/10	1	51W	12V	5994100010227
93105775	28076	H8	13	BL1 1/10	1	35W	12V	5994100010128
93105776	28077	H9	15	BL1 1/10	1	65W	12V	5994100010135
93105794	28078	H11	16	BL1 1/10	1	55W	12V	5994100010142
93088856	1057	P21W	21	BL2 1/10 set	2	21W	12V	5994100005445
93088264	1057L	P21W Long Life	21L	BL2 1/10 set	2	21W	12V	5994100005520
93089848	1077	P21/5W	23	BL2 1/10 set	2	21/5W	12V	5994100005612
93088860	1077L	P21/5W Long Life	23L	BL2 1/10 set	2	21/5W	12V	5994100005636
93105790	1078	P21/5W	93	BL2 1/10 set	2	21/5W	24V	5994100009917
93105791	1098	20/5W	48	BL2 1/10 set	2	20/5W	12V	5994100009924
93105785	1122	P21/4W	20	BL2 1/10 set	2	21/4W	12V	5994100009931
93088263	1056	PY21W	22	BL2 1/10 set	2	21W	12V	5994100005414
93105772	2619	R5W	24	BL2 1/10 set	2	5W	12V	5994100009955
93105780	2619L	R5W Long Life	24L	BL2 1/10 set	2	5W	12V	5994100009962
93105773	2662	T4W	26	BL2 1/10 set	2	4W	12V	5994100009986
93111368	2662L	T4W Long Life	26L	BL2 1/10 set	2	4W	12V	5994100029311
93105771	2641	R10W	30	BL2 1/10 set	2	10W	12V	5994100009979
93105782	5301	W1,2W	29	BL2 1/10 set	2	1,2W	12V	5994100010111
93105783	5304	W3W	27	BL2 1/10 set	2	3W	12V	5994100010067
93105774	501	W5W	28	BL2 1/10 set	2	5W	12V	5994100009993
93105795	501NA	WY5W	33	BL2 1/10 set	2	5W	12V	5994100010005
93111385	501NB	W5W	28	BL2 1/10 set	2	5W	12V	5994100029274
93105770	7546	C5W	25	BL2 1/10 set	2	5W	12V	5994100010173
93111369	7546L	C5W Long Life	25L	BL2 1/10 set	2	5W	12V	5994100029304
93105786	7575	7575	40	BL2 1/10 set	2	5W	12V	5994100010180
93105784	7576	DIN 72601K	31	BL2 1/10 set	2	10W	12V	5994100010197
93110517	91735	91735	32	BL2 1/10 set	2	10W	12V	5994100027966
93105792	7592	72601K	42	BL2 1/10 set	2	10W	12V	5994100010203
93111372	52830U	H6W	62	BL1 1/10	1	6W	12V	5994100029144
93110528	7440	W21W	50	BL2 1/10 set	2	21W	12V	5994100027942
93110537	7443	W21/5W	49	BL2 1/10 set	2	21/5W	12V	5994100027935
93110524	7440NA	WY21W	51	BL2 1/10 set	2	21W	12V	5994100027959
93111386	WY16W	WY16W	52	BL2 1/10 set	2	16W	12V	5994100029267
93118393	60140	LED W3W, W5W	57	BL1 1/10	1	0.5W	12V	5994100072546
93095655	60210	LED DIN72601K	59	BL1 1/10	1	0.5W	12V	5994100006909
93108744	60200	LED C5W	65	BL1 1/10	1	0.5W	12V	5994100010258
93118392	60170	LED W3W, W5W	67	BL1 1/10	1	0.5W	12V	5994100072539
93095654	60240	LED DIN72601K	61	BL1 1/10	1	0.5W	12V	5994100006916
93108743	60230	LED C5W	66	BL1 1/10	1	0.5W	12V	5994100011934
93116981	60570	LED Festoon 28mm	81	BL1 1/10	1	0.7	12V	5994100054276
93116983	60590	LED Festoon 31mm	83	BL1 1/10	1	0.7	12V	5994100054290
93116985	60630	LED P21W	85	BL1 1/10	1	3	12V	5994100054818
93117017	60650	LED P21/5W	87	BL1 1/10	1	3/0.55W	12V	5994100054832
93117021	60690	LED W21W	91	BL1 1/10	1	3	12V	5994100054870
93117023	60710	LED W21/5W	94	BL1 1/10	1	3/0.55W	12V	5994100054894
93117031	60790	LED M5	98	BL1 1/10	1	5	12V	5994100054979
93116980	60560	LED Festoon 28mm	80	BL1 1/10	1	0.7	12V	5994100054269
93116982	60580	LED Festoon 31mm	82	BL1 1/10	1	0.7	12V	5994100054283
93116984	60620	LED P21W	84	BL1 1/10	1	3	12V	5994100054306
93117016	60640	LED P21/5W	86	BL1 1/10	1	3/0.55W	12V	5994100054825
93117020	60680	LED W21W	90	BL1 1/10	1	3	12V	5994100054863
93117022	60700	LED W21/5W	92	BL1 1/10	1	3/0.55W	12V	5994100054887
93117030	60780	LED M5	97	BL1 1/10	1	5	12V	5994100054962
93117025	60730	LED W21/5W	96	BL1 1/10	1	3/0.55W	12V	5994100054917
93117018	60660	LED P21W	88	BL1 1/10	1	3	12V	5994100054849
93117019	60670	LED P21/5W	89	BL1 1/10	1	3/0.55W	12V	5994100054856
93117024	60720	LED W21W	95	BL1 1/10	1	3	12V	5994100054900
93120755	60930	LED PY21W	99	BL1 1/10	1	2,3	12/24V	5994100094357
93120766	60950	LED WY21W	100	BL1 1/10	1	2,3	12/24V	5994100094364
93120767	60870	LED W16W	101	BL1 1/10	1	2	12V	5994100094340
93120754	60980	LED WY5W	102	BL1 1/10	1	0,5	12V	5994100094333

# Symbols used on the packaging

- Do not touch with bare fingers**: Icon of a hand touching a lamp.
- No disposal as household waste**: Icon of a crossed-out trash bin.
- For removal and installation use appropriate eye protection**: Icon of a person wearing safety glasses.
- Dangerous voltage**: Icon of a lightning bolt.
- Installation and servicing of electronic device only by qualified electrical employees**: Icon of a person with a wrench and screwdriver.
- For removal and installation use appropriate gloves**: Icon of a hand wearing a glove.
- Read attached instructions before use**: Icon of a document with a hand pointing to it.
- Operation only in luminaire installations with protective shield**: Icon of a lamp inside a protective shield.
- Don't let children play with bulbs**: Icon of a child with a crossed-out play symbol.
- No operation of lamps with scratched or damaged glass bulb**: Icon of a lamp with a cracked glass bulb.
- Beware of temperature**: Icon of a thermometer showing a high temperature (> 200°C).
- Switch off light before re-lamping**: Icon showing a light switch being turned off.
- Not suitable for household use**: Icon of a house with a crossed-out light bulb.
- Use as vehicle lamp 12V or 24V**: Icon of a car with a light bulb.

# Base stamps on the Tungsrám automotive lamps

## Halogen auto lamp marking

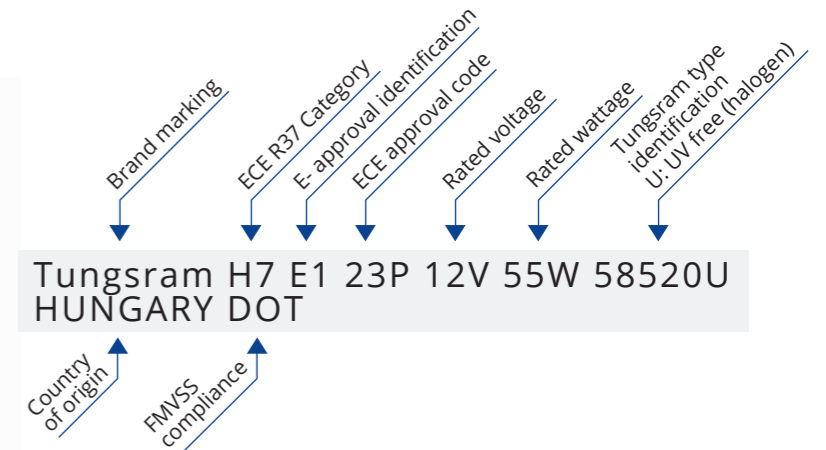

## Miniature auto lamp marking

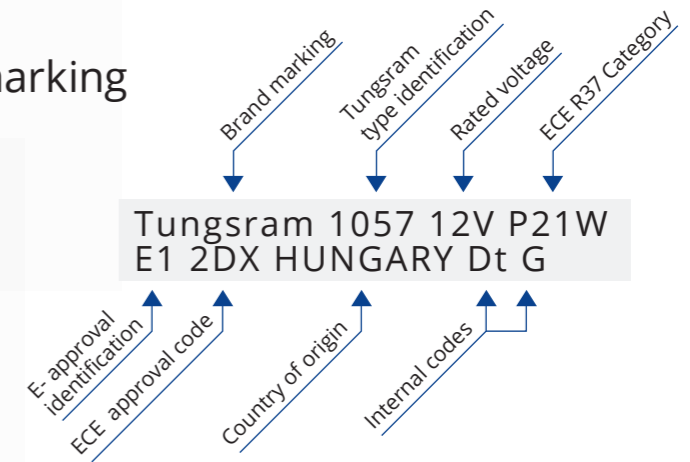

# Lamp bases

Culot – Sockelübersicht – Casquillos de lámparas – Attacchi lampade



**TUNGSRAM™**

Innovation is our heritage  
EST. 1896



OEM quality  
automotive lamps  
by Tungstram







[automotive.tungram.com](https://automotive.tungram.com)

We in Tungram Operations Kft. are constantly developing and improving our products. For this reason, all product descriptions in this catalogue are intended as a general guide, and we may change specifications from time to time in the interest of product development, without prior notification or public announcement. All descriptions in this publication present only general particulars of the goods to which they refer and shall not form part of any contract. Data in this guide has been obtained in controlled experimental conditions. However, Tungram cannot accept any liability arising from the reliance on such data to the extent permitted by law.

09/2021